

Protein Electrophoresis

technical manual

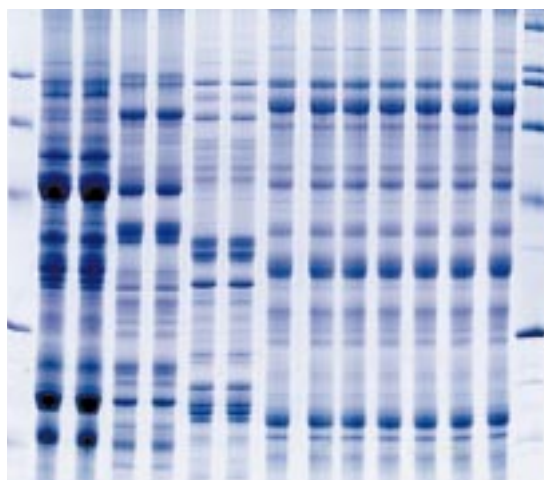

This technical manual contains information that has been distilled from more than 30 years of laboratory experience in developing and verifying applications and product performance for protein electrophoresis. As such it is ideal for both new and current users of protein electrophoresis as both a teaching and a reference guide. The first chapter provides a theoretical framework, and Chapters 2 through 4 cover the major aspects of protein electrophoretic separation: polyacrylamide gel electrophoresis, isoelectric focusing, and gel analysis. In addition, an extensive reference list is summarized at the end of every chapter, and a detailed glossary is included at the end of the manual.

Page finder

Safety	iii
---------------------	-----

Chapter 1

Introduction to Electrophoretic Theory	1
1.0 Principles of electrophoresis	1
1.1 Electrical parameters	2
1.2 Buffers and pH	3
1.3 Effects of heat on separations	4
1.4 Matrix	5
1.4.1 Agarose gels	6
1.4.2 Polyacrylamide gels	6
1.5 Analysis of the results	8
1.5.1 Detection	8
1.5.2 Quantification	9
1.6 Blotting	10
1.6.1 Transfer	10
1.6.2 Detection	11
1.7 Protocols in this manual	11
1.8 References and bibliography	11

Chapter 2

Polyacrylamide Gel Electrophoresis	13
2.1 Equipment choices	13
2.2 Separating proteins on the basis of molecular weight:	
SDS gel electrophoresis	13
2.2.1 Introduction	13
2.2.2 Stock solutions	16
2.2.3 Materials and equipment	18
2.2.4 Procedure	19
2.3 Separating proteins on denaturing mini-gels	23
2.3.1 Introduction	23
2.3.2 Materials and equipment	24
2.3.3 Procedure	24
2.4 Preparing linear gradient gels	30
2.4.1 Introduction	30
2.4.2 Materials and equipment	30
2.4.3 Procedure	30
2.5 Native gel electrophoresis	36
2.6 Separating proteins by flatbed SDS-PAGE	36
2.6.1 Introduction	36
2.6.2 Materials and equipment	36
2.6.3 Procedure	38
2.7 Troubleshooting	39
2.8 References and bibliography	41

Chapter 3

Isoelectric focusing of proteins	43
3.0 Introduction	43
3.1 Native isoelectric focusing	45
3.1.1 Solutions	45
3.1.2 Materials and equipment	46
3.1.3 Procedure	46
3.2 Denaturing isoelectric focusing	48
3.2.1 Solutions	48
3.2.2 Materials and equipment	48
3.2.3 Procedure	48
3.3 Isoelectric focusing using immobilized pH gradient (IPG) gels	50
3.3.1 Materials and equipment	50
3.3.2 Procedure	51
3.4 Troubleshooting	53
3.5 References and bibliography	53

Chapter 4

Analysis of gels	55
4.1 Staining Gels with Coomassie Brilliant Blue	55
4.1.1 Coomassie Blue staining stock solutions	56
4.1.2 Materials and equipment	57
4.1.3 Standard Coomassie Blue protocol	57
4.1.4 Automated Coomassie Blue staining	58
4.2 Silver Staining	58
4.2.1 Silver staining stock solutions	59
4.2.2 Materials and equipment	60
4.2.3 Silver staining protocol	60
4.3 Gel drying and storage	61
4.3.1 Storage	61
4.3.2 Drying gels by vacuum	61
4.3.3 Air drying using Easy Breeze	61
4.4 Documentation	62
4.4.1 Photography	62
4.4.2 Densitometer	62
4.4.3 Scanners and digital cameras	62
4.5 Estimation of protein molecular weights by SDS gel electrophoresis	62
4.5.1 Materials and equipment	62
4.5.2 Procedure	63
4.6 Troubleshooting	66
4.7 References and bibliography	66
Glossary	67
Index	69

Safety

Safety considerations are important during the preparation and execution of these laboratory experiments. Chemical and electrical hazards, two principal areas specifically related to electrophoresis, are discussed below. For full information concerning the safety and hazardous materials handling practices of your institution, contact your health and safety officer.

Chemical safety

Some of the chemicals used in these procedures are hazardous. Acrylamide monomer, for example, is a neurotoxin and suspected carcinogen. You should have a manufacturer's safety data sheet (MSDS) detailing the properties and precautions for all chemicals in your lab. The safety sheets should be reviewed prior to starting the procedures in this manual. General handling procedures include using double latex gloves for all protocols and weighing hazardous materials in a hood while wearing a disposable dust mask.

Electrical safety

The voltage and current used in these exercises are potentially lethal. The following items should be checked prior to initiating any experiment in electrophoresis.

- Work area. The bench and floor should be dry.
- High-voltage connections. The high-voltage leads should be intact and not frayed. The plug should have a protective plastic sleeve that shields the plug as it is inserted into the power supply. Exposed plugs are a shock hazard and should be replaced with shielded plugs. Stackable leads that connect more than one gel unit to a single outlet are not recommended and should be replaced with shielded-style plugs.
- Electrophoresis chambers. These should be covered when in use, with no openings large enough to allow fingers or other objects to make contact with the electrified buffer or electrodes.
- Power supplies. All newer power supplies have deeply recessed outputs that minimize the possibility of contacting the electrically active plug or high-voltage input jacks. Older power supplies do not have recessed jacks and, when used in combination with old-style banana plugs, pose a serious shock hazard and require special caution to use. Without the protection of the shield, a researcher can make contact with the plug while it is still connected to the power supply and receive a potentially lethal shock.

continued on following page

The following power connection protocol should minimize these hazards and is recommended for all power supplies:

- Start with power supply off and with voltage and current controls set at zero.
- Connect the gel box and leads to power supply.

Caution. When connecting high-voltage leads to the power supply, use your right hand only. Because of the potential for lethal shock across the chest do not use both hands to plug in (or unplug!) power supply leads. Also, make sure your left hand is not touching anything that would ground you.

- Turn on the power supply and set for the desired current or voltage.
- At the end of the run, turn the voltage and current to zero and then turn off the power supply at the AC mains.

Caution. Power supplies have internal capacitance that stores electrical charge even after the power supply is turned off. This stored charge can deliver a potentially lethal shock should the operator come in contact with the positive and negative output. Bringing the voltage and current display to zero indicates the power supply can be safely turned off.

- Unplug the high-voltage leads using your right hand only.

Chapter 1

Introduction to electrophoretic theory

1.0 Principles of electrophoresis

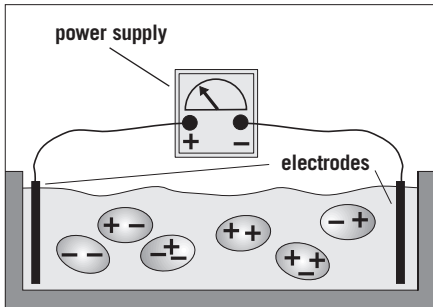

Fig 1.1. Basic arrangement for electrophoresis.

Electrophoresis is the process of moving charged molecules in solution by applying an electric field across the mixture (Fig 1.1). Because molecules in an electric field move with a speed dependent on their charge, shape, and size, electrophoresis has been extensively developed for molecular separations. As an analytical tool, electrophoresis is simple and relatively rapid. It is used chiefly for analysis and purification of very large molecules such as proteins and nucleic acids, but can also be applied to simpler charged molecules, including charged sugars, amino acids, peptides, nucleotides, and simple ions. Highly sensitive detection methods have been developed to monitor and analyze electrophoretic separations.

Electrophoresis of macromolecules is normally carried out by applying a thin layer of a sample to a solution stabilized by a porous matrix. Under the influence of an applied voltage, different species of molecules in the sample move through the matrix at different velocities. At the end of the separation, the different species are detected as bands at different positions in the matrix. A matrix is required because the electric current passing through the electrophoresis solution generates heat, which causes diffusion and convective mixing of the bands in the absence of a stabilizing medium. The matrix can be composed of a number of different materials, including paper, cellulose acetate, or gels made of polyacrylamide, agarose, or starch. In acrylamide and agarose gels, the matrix also acts as a size-selective sieve in the separation. At the end of the run, the separated molecules can be detected in position in the gel by staining or autoradiography, quantified by scanning with a densitometer, and the gel can be dried for permanent storage.

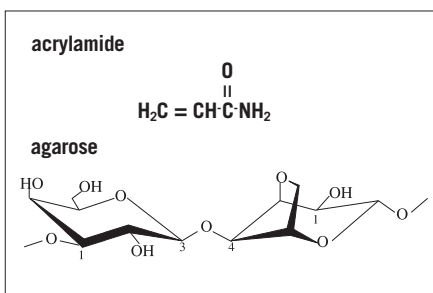

Fig 1.2. Chemical structure of acrylamide and agarose.

Polyacrylamide and agarose gels (Fig 1.2) are the most common stabilizing media used in research laboratories. The gels are usually formed as cylinders in tubes, or as thin, flat slabs or sheets. Polyacrylamide is the most common matrix for separating proteins. Nucleic acids are separated on either polyacrylamide or agarose gels, depending on the sizes of molecules to be analyzed. The choice of matrix and concentration effects on size separation are discussed further in section 1.4.

In most electrophoresis units, the gel is mounted between two buffer chambers in such a way that the only electrical connection between the two chambers is through the gel. Contact between the buffer and gel may be direct liquid contact (Fig 1.3a–c) or through a wick or pad of paper or gel material (Fig 1.3d). Although vertical tube and slab gels (Fig 1.3a–b), which have direct liquid buffer connections, make the most efficient use of the electric field, the apparatus presents some mechanical difficulties in equipment design: The connections must be liquidtight, electrically safe

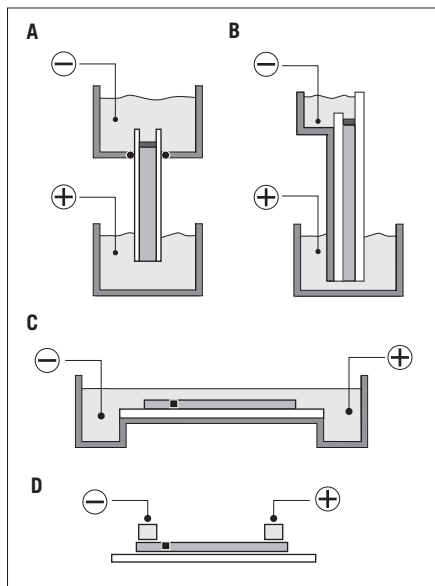

Fig 1.3. Cross-section diagrams of gel apparatus designs: (A) tube, (B) vertical slab, (C) horizontal submarine, (D) horizontal thin layer with buffer pads.

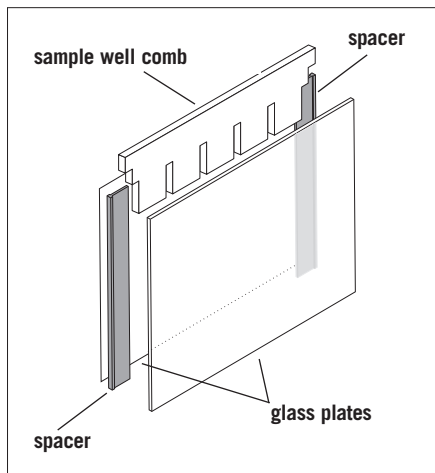

Fig 1.4. Diagram of vertical slab gel assembly ("sandwich"). The sides and bottom must be sealed liquidtight when the gel is cast.

and convenient to use. The search for convenience has led to several alternative methods for connecting buffer and gel. Paper or gel wicks connecting the reservoir to the gel were early designs that are used only rarely now. "Submarine gels" are run in a horizontal orientation with the gel resting on a platform between the buffer reservoirs, submerged under a layer of a few millimeters of buffer (Fig 1.3c). For other horizontal applications, the buffer reservoir has been reduced to a moist pad of buffer-saturated paper or gel material that serves as a contact bridge between the electrodes and the separation gel (Fig 1.3d).

Gels can be of all sizes, depending on the separation distance needed and the amount of sample. Analytical tube gels are commonly cast in glass tubes with an inside diameter of 1–5 mm and a length of 5–25 cm. Preparative tube gels may range up to 10 cm in diameter to accommodate larger amounts of material. At the other extreme, gels run in capillaries 50–100 μm in diameter and 30–100 cm long provide very high resolution and rapid separations of very small amounts of sample.

Vertical slab gels are normally cast between a pair of glass plates for support. A chamber is constructed by separating the two plates with spacer strips down the edges of the plates, then sealing the edges and bottom to form a liquidtight box or "sandwich" (Fig 1.4). Slab gels range in size from 2.5 cm square (between microscope coverslips) to 30 \times 150 cm square and from <0.05 mm to >5 mm thick.

Horizontal acrylamide gels, like vertical slabs, must be polymerized between plates, because the acrylamide polymerization is oxygen sensitive. After polymerization one glass plate is removed to expose the gel surface. In contrast, horizontal agarose gels may be cast simply by pouring molten agarose onto a glass or plastic plate. Horizontal gels range in size from 2.5 \times 5 cm square to 20 \times 30 cm square and from <0.05 mm to >10 mm thick.

1.1 Electrical parameters

The fundamental driving force of electrophoresis is the voltage applied to the system. The speed of a molecule is directly proportional to the surrounding voltage gradient. Two basic electrical equations are important in electrophoresis. The first is Ohm's Law:

$$V = IR \text{ or } I = \frac{V}{R} \quad (\text{eq 1})$$

Ohm's Law relates voltage (V) measured in volts (V), current (I) measured in amperes (A), and resistance (R) measured in ohms (Ω). The second fundamental equation in electrophoresis is the power equation, which describes the amount of heat produced in a circuit. It can be written in several forms:

$$P = VI \text{ or } P = I^2R \text{ or } P = \frac{V^2}{R} \quad (\text{eq 2})$$

where P is power, which is measured in watts (W). This heat is also referred to as *Joule heat*. In the electrophoresis circuit, voltage and current are supplied by a DC power supply; the leads, electrodes, buffer, and gel all act as simple resistors.

Power supplies used for electrophoresis hold one electrical parameter (current, voltage, or power) constant. The resistance of the electrophoresis circuit, however, does not remain constant during a run. Buffer resistance declines with increasing temperature caused by Joule heating. Resistance also changes as discontinuous buffer ion fronts move through a gel; in the case of discontinuous denaturing *polyacrylamide gel electrophoresis* (SDS-PAGE), resistance increases as the run progresses. Depending on the buffer and which electrical parameter is held constant, the Joule heating of the gel may increase or decrease over the period of the run.

Table 1.1. Effect of power supply mode on heat generation

Buffer system effect	Change during run	Power supply constant mode	Heat
Discontinuous (SDS-PAGE)	↑ R	current (I_c) voltage (V_c)	↑ P ↓ P
Continuous (Blotting, DNA)	↓ R	current (I_c) voltage (V_c)	↓ P ↑ P

Table 1.1 illustrates the change in P (and temperature) observed under different electrophoresis conditions. For discontinuous SDS-PAGE, running at constant current leads to increasing heat generation and may require active heat removal. By contrast, continuous buffer systems, such as those used in electrophoretic blotting or DNA gels, will tend to overheat when run at constant voltage. Whenever overheating is a potential problem, a method of heat removal should be supplied (a circulating thermostatted bath or cold tap water) or low voltage/current conditions should be applied to prevent heat-induced artifacts or damage to the instrument.

The choice of the power supply constant mode for an electrophoresis experiment must include consideration of several variables, including the time available, the need to minimize sample diffusion and loss of sample activity caused by either heat or time, and the need to maintain a specific temperature for the run. Conventionally, protein gels are run at constant current, nucleic acid separations are performed at constant voltage, and DNA sequencing gels are run under constant power conditions. Most protein isoelectric focusing experiments use constant power because the resistance of the gel becomes very high as the separation nears completion.

1.2 Buffers and pH

Proteins are amphoteric (or zwitterionic) compounds and are therefore either positively or negatively charged because they contain both acidic and basic residues. Nucleic acids are not amphoteric and remain negatively charged at the pH used for most electrophoresis buffers because of the strong acid nature of the phosphate groups in the backbone.

Most of the charge of a protein comes from the pH-dependent ionization of amino acid side-chain carboxyl and amino groups ($-\text{COOH} \leftrightarrow \text{COO}^- + \text{H}^+$; $-\text{NH}_2 + \text{H}^+ \leftrightarrow \text{NH}_3^+$). Histidine, a weakly basic amino acid, also contributes to the charge. Because these groups can be titrated over normal electrophoresis pH ranges, the net charge of a protein is determined by the pH of the surrounding medium and the number and types of amino acids carrying amino or carboxyl groups. Post-translational modifications such as the addition of charged and uncharged sugars, sulphhydryl cross-links, and blocking amino or carboxyl termini, also may alter the charge on a protein.

For each protein species, there is a pH at which the molecule has no net charge. At this pH, called the *isoelectric point* or *pI*, the weak acids and bases are titrated to the point that there is an equal number of positive and negative charges on the molecule. Each protein has a unique pI. For example, the pI of human hemoglobin is at pH 7.07; that of β -lactoglobulin is at pH 5.34. In a solution with a pH above the isoelectric point, a protein has a net negative charge and migrates toward the positive electrode (anode) in an electric field. When in a solution below a protein's isoelectric point, the protein charge is positive and migrates toward the negative electrode (cathode).

For electrophoretic protein separations based on the mobility of the different species, the pH of the solution must be kept constant to maintain the charge and, hence, the mobilities of the proteins. Therefore, because electrolysis of water generates H^+ at the anode and OH^- at the cathode, the solutions used in electrophoresis must be buffered. On the other hand, the pH-dependent mobility of proteins can be used to separate them by their isoelectric points in another separation technique called *isoelectric focusing* (*IEF*). In IEF proteins are electrophoresed into a pH gradient. As the proteins move through the gradient, they encounter a point where the pH is equal to their pI and they stop migrating. Because of differences in pI, different proteins will stop (“focus”) at different points in the gradient.

1.3 Effects of heat on separations

Temperature regulation is critical at every stage of electrophoresis if reproducibility is important. For example, acrylamide polymerization is an exothermic reaction, and during polymerization—particularly of high-concentration gels—the heat of polymerization may cause convection flows that lead to irregularities in the sieving pore sizes of the gel. Convection is not usually a problem for gels of <15%T.

Heat can cause a number of problems during electrophoresis:

- Excessive heat can cause agarose gels to melt, glass plates to break, or damage to the electrophoresis unit.
- When separating native proteins by electrophoresis, the Joule heat must be controlled, either by active cooling or by running the gel at low voltages, to prevent heat denaturation or inactivation of the proteins.
- Nonuniform heat distribution distorts band shapes due to different mobilities at different temperatures. Slab gels are described as “smiling” when the samples in the center lanes move faster than samples in the outer lanes. This effect is due to more-rapid heat loss from the edges of the gel than from the center. Bands may appear as doublets or broader than expected when the front and rear vertical glass plates or the top and bottom of a horizontal slab are at different temperatures.

Recognizing and dealing with these problems is covered more thoroughly in the troubleshooting sections of this guide.

To maintain acceptable temperature control and uniformity throughout the gel and the run, the electrophoresis equipment must be designed for efficient heat transfer. The unit must provide good contact between the gel and a heat sink, and between the heat sink and a heat exchanger. A proven design for vertical slab and tube gel units uses the buffer as a heat sink. When most of the length of the gel tube or slab assembly makes contact with the buffer, heat is transferred quickly and uniformly out of the gel. A heat exchanger in contact with the buffer then transfers the heat to an external coolant. Many DNA sequencing units use an aluminum plate in contact with one side of the slab assembly to distribute heat evenly across the gel and reduce smearing. Sequencing units normally do not require cooling, because they are intentionally run at 40–60 °C. Horizontal slab gels may be cast directly on the surface of a heat exchanger. Some electrophoresis unit designs require that the buffer be pumped through an external loop to a refrigerated bath. This type of design poses an electrical hazard if the pump or tubing develops a leak.

1.4 Matrix

Agarose and polyacrylamide gels are cross-linked, spongelike structures. Although they are up to 99.5% water, the size of the pores of these gels is similar to the sizes of many proteins and nucleic acids. As molecules are forced through the gel by the applied voltage, larger molecules are retarded by the gel more than are smaller molecules. For any particular gel, molecules smaller than a matrix-determined size are not retarded at all; they move almost as if in free solution. At the other extreme, molecules larger than a matrix-determined size cannot enter the gel at all. Gels can be tailored to sieve molecules of a wide range of sizes by appropriate choice of matrix concentration. The average pore size of a gel is determined by the percentage of solids in the gel and, for polyacrylamide, the amount of cross-linker and total amount of polyacrylamide used.

Polyacrylamide, which makes a small-pore gel, is used to separate most proteins, ranging in molecular weight from <5 000 to >200 000, and polynucleotides from <5 bases up to ~2 000 base pairs in size. Because the pores of an agarose gel are large, agarose is used to separate macromolecules such as nucleic acids, large proteins, and protein complexes. Various types of agarose can separate nucleic acids from 50 to 30 000 base pairs and, with pulsed-field techniques, up to chromosome- and similar-sized pieces $>5 \times 10^6$ base pairs long.

Whichever matrix is selected, it is important that it be electrically neutral. Charged matrices may interact chromatographically with molecules and retard migration. The presence of fixed charged groups on the matrix will also cause the flow of water toward one or the other electrode, usually the cathode. This phenomenon, called *electroendosmosis* (often abbreviated *EEO* in supplier literature), usually decreases the resolution of the separation.

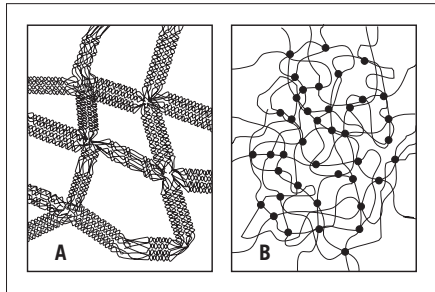

Fig 1.5. Agarose and acrylamide gels. (A) Agarose gels form by noncovalent hydrogen and hydrophobic bonds between long sugar polymers. (B) Acrylamide gels have covalent cross-links (•) between polymer strands.

1.4.1 Agarose gels

Agarose can be used for isoelectric focusing and separation of large proteins or protein complexes. Agarose is a highly purified polysaccharide derived from agar. For protein IEF applications, the critical qualities are low EEO and good clarity at the working concentration. When used in a thin horizontal format for IEF, agarose gels must be supported on a plastic backing and cooled during electrophoresis.

Agarose is normally purchased as a dry powder. It dissolves when the suspended powder is heated to near boiling and it remains liquid until the temperature drops to about 40 °C, when it gels or “sets.” There are specific types of agarose that have melting and gelling temperatures considerably lower than those of standard agarose. These properties improve the recovery of material from a gel after separation for subsequent enzymatic treatments of the separated material.

The pore size and sieving characteristics of a gel are determined by adjusting the concentration of agarose in the gel. The higher the concentration, the smaller the pore size. Working concentrations are normally in the range of 0.4–4% w/v.

Agarose gels are relatively fragile and should be handled carefully. The gels are hydrocolloids, held together by hydrogen and hydrophobic bonds, and tend to be somewhat brittle (Fig 1.5a). An agarose gel should always be handled with some form of support for the entire gel, such as a tray or wide spatula, because the gel will break if it bends too far.

1.4.2 Polyacrylamide gels

Polyacrylamide gels are physically tougher than agarose gels. The gel forms when a mixed solution of acrylamide and cross-linker monomers co-polymerize into long chains that are covalently cross-linked. The gel structure is held together by the cross-linker (Fig 1.5b). The most common cross-linker is N,N'-methylenebisacrylamide (“bis” for short). Other cross-linkers that can be cleaved after polymerization are available (e.g. N,N'-bis-[acryloyl]-cystamine can be cleaved by disulphide reducing agents); they aid in recovering separated species from the gel by allowing the polymerized acrylamide to be solubilized.

Because polymerization of acrylamide is a free-radical catalyzed reaction, preparation of polyacrylamide gels is somewhat more complex than that of agarose gels. Some of the technical issues are discussed in the following sections.

Preparing and pouring the monomer solution

Atmospheric oxygen is a free-radical scavenger that can inhibit polymerization. For consistent results the acrylamide monomer solution is deaerated by purging it with an inert gas or by exposing it to a vacuum for a few minutes. Preparing solutions with a minimum of stirring, which introduces air, will reduce oxygen inhibition problems.

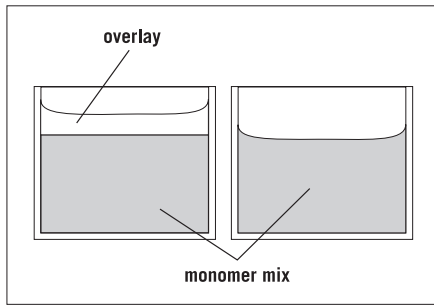

Fig 1.6. Meniscus effect on gel shape. Overlaying the gel mix with water or n-butanol gives a flat gel surface for flat sample bands.

$$\%T = \frac{\text{g(acrylamide + bisacrylamide)}}{100 \text{ ml}} \times 100$$

$$\%C = \frac{\text{g(bisacrylamide)}}{\text{g(acrylamide + bisacrylamide)}} \times 100$$

Fig 1.7. Determination of %T and %C for acrylamide gels.

When the gel solution is poured into a tube or slab mold, the top of the solution forms a meniscus. If the meniscus is ignored, the gel will polymerize with a curved top, which will cause the separated sample bands to have a similar curved pattern. To eliminate the meniscus, a thin layer of water, buffer, or water-saturated n-butanol is carefully layered on the surface of the gel mixture before it polymerizes (Fig 1.6). After polymerization the water or butanol layer is poured off, leaving the upper surface of the gel flat. The layer of water or water-saturated butanol also excludes oxygen, which would otherwise inhibit polymerization on the gel surface.

Alternatively, a flat-edged form, such as a comb, can be inserted into the top of the solution to give a mechanically flat surface. Care must be taken not to trap small air bubbles under the bottom edge of a comb. Combs made of Teflon will inhibit polymerization of a thin layer immediately next to the comb, because of oxygen dissolved in the plastic of the comb. This unpolymerized layer is convenient because it eases removing the comb without affecting the performance of the gel.

Determining the pore size

The size of the pores in a polyacrylamide gel is determined by two parameters: total solids content (%T) and the ratio of cross-linker to acrylamide monomer (%C) (Fig 1.7). The %T is the ratio of the sum of the weights of the acrylamide monomer and the cross-linker in the solution, expressed as % w/v. For example, a 20%T gel would contain 20% w/v of acrylamide plus bisacrylamide. As the %T increases, the pore size decreases.

The second way to adjust pore size is to vary the amount of cross-linker. The %C is the weight/weight percentage of total cross-linker weight in the sum of monomer and cross-linker weights. Thus, a 20%T 5% C_{bis} gel would have 20% w/v of acrylamide plus bis, and the bis would account for 5% of the total solids weight (acrylamide plus bis). Occasionally, gel compositions are given as ratios of acrylamide to cross-linker (such as 19:1 for the 20%T 5%C mixture). It has been found that for any single %T, 5% cross-linking creates the smallest pores in a gel. Above and below 5%, the pore size increases.

If the material under study is a mixture with species having a wide range of molecular weights, you may want to use a pore-gradient gel. In these gels the pore size is larger at the top of the gel than at the bottom; the gel becomes more restrictive as the run progresses. The presence of the gradient yields a gel with a wider range of size resolution and also keeps bands tighter than in uniform-concentration gels.

Polymerizing the gel

The free-radical vinyl polymerization of acrylamide gel can be initiated either by a chemical peroxide or by a photochemical method. The most common method uses ammonium persulphate as the initiator peroxide and the quaternary amine, N,N,N',N'-tetramethylethylenediamine (TEMED) as the catalyst.

For photochemical polymerization, riboflavin and long-wave UV light are the initiator, and TEMED is the catalyst. Shining long-wavelength ultraviolet light on the gel mixture, usually from a fluorescent light, starts the photochemical reaction. Photochemical polymerization is used when the ionic strength in the gel must be very low, because only a minute amount of riboflavin is required. It is also used if the protein studied is sensitive to ammonium persulphate or the by-products of peroxide-initiated polymerization.

Polymerization of acrylamide generates heat. Rapid polymerization can generate too much heat, causing convection inconsistencies in the gel structure and occasionally breaking glass plates. It is a particular problem for high-concentration gels (>20%T). To prevent excessive heating, the concentration of initiator-catalyst reagents should be adjusted so that complete polymerization requires 20–60 min.

1.5 Analysis of the results

1.5.1 Detection

After the electrophoresis run is complete, the gel must be analyzed qualitatively or quantitatively to answer analytical or experimental questions. Because most proteins and all nucleic acids are not directly visible, the gel must be processed to determine the location and amount of the separated molecules.

The most common analytical procedure is staining. Proteins are usually stained with Coomassie™ Brilliant Blue in a fixative solution or, after fixation, with silver by a photographic-type development. With Coomassie Blue staining, about 0.1–0.3 µg of protein is the lower detectable limit in a band, and even less for some proteins. The silver staining systems are about 100 times more sensitive, with a lower detection limit of about 1 ng of protein. Once the gel is stained, it can be photographed, scanned, or dried on a transparent backing or filter paper for a record of the position and intensity of each band.

Nucleic acids are usually stained with ethidium bromide, a dye that fluoresces weakly in free solution but exhibits strong orange fluorescence when bound to nucleic acids and excited by UV light. About 10–50 ng of double-stranded DNA can be detected with ethidium bromide on a 300 nm UV transilluminator. Fluorescent gels must be photographed for a record of the separation.

Radioactively labelled samples separated on a slab gel are commonly detected by autoradiography. The gel is first dried to a sheet of filter paper and then placed in contact with X-ray film. The beta or gamma particles emitted in a radioactive decay event expose the film the same way light or X-rays do. After standard photographic development, the bands or spots seen on the film correspond to the bands or spots in the gel. The resulting autoradiograph is a permanent record of the results of the separation.

1.5.2 Quantification

Amount

Qualitative analysis of gels for the presence or absence of a band or spot or relative mobilities of two bands can easily be performed by visual inspection. Answering “How much?” and “What size?” questions requires additional work. The amount of material in a band can be determined to various levels of accuracy by a number of methods. The simplest is to visually compare the intensity of a band, either stained or autoradiographic, to standards of known quantity on the same gel. More-accurate answers can be determined by using a densitometer to scan the stained gel or photograph/autoradiograph of the gel. As gel documentation systems have become increasingly available in laboratories, electronic acquisition of data (video cameras, desktop scanners) is replacing photographs. Image analysis software allows easy and rapid analysis of separated proteins, including automatic calculation of amount and molecular weight. Traditional methods of quantification of radioactive bands by excision and scintillation counting has largely been replaced by the use of radioanalytical devices that directly scan and quantify the signals from radioactive gel bands. Native enzymes can be excised and assayed by their standard assay. For quantitative analysis it is always advisable to have known standards as controls for staining efficiency, film nonlinearity, or recovery yields.

Size

Determining the size of a macromolecule by its mobility also requires standards of known size for comparison. Because shape affects the mobility of a molecule through a sieving gel, all the molecules in one gel must have similar shapes for valid comparisons. This does not present a problem for double-stranded DNA, because the shape of the molecules is virtually sequence-independent. Single-stranded nucleic acids and proteins, however, must be denatured to ensure similar random coil shapes. For RNA or single-stranded DNA, denaturants added to the buffer may include formamide, urea, formaldehyde, or methylmercury hydroxide. Nucleic acids can also be denatured by treatment with glyoxal before electrophoresis.

Proteins can be denatured with urea or sodium dodecylsulphate (SDS). SDS denatures proteins by forming a stable complex that removes most native folded structure. The amount of SDS in the complex depends only on the size of the protein, not on charge or sequence. The strong negative charge of the SDS molecules in the complex masks any pI differences that might affect electrophoretic mobility. The resulting protein/SDS complex is a random coil that has a negative charge dependent on the size of the protein, not on its sequence.

Both protein and nucleic acid size standards are available commercially. These standards are sets of well-characterized molecules that can be run in lanes adjoining experimental samples for size comparison. Approximate

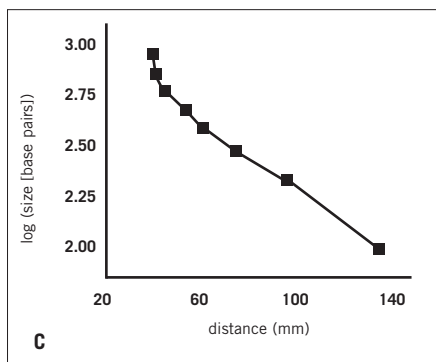
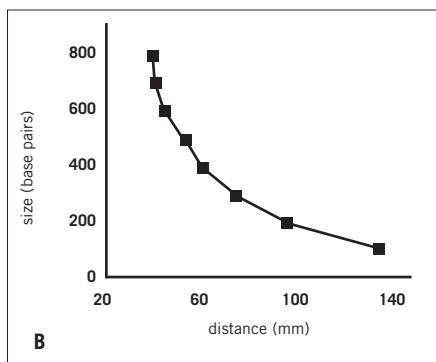
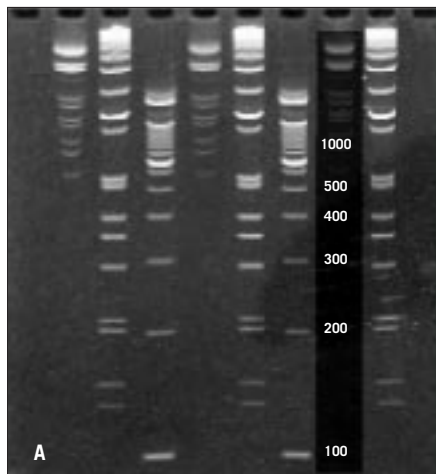

Fig 1.8. Analyzing gels for size information. (A) Acrylamide DNA gel. (B) Plot of size (bp) versus distance migrated. (C) Plot of log (size [bp]) versus distance.

sizes of unknown species can be estimated by visual comparison to the standard. For more-accurate estimates, standard band mobilities are used to generate a calibration curve, then unknown sizes are read off of the curve. Because the sizes of molecules are not a simple function of distance moved through a gel, the best estimates of unknown sizes require having several standards both smaller and larger than the molecule of interest. Plots of DNA molecule length (in base pairs) as a function of distance are shown in Figure 1.8. For comparison, protein molecular weight plots are shown in Figures 4.9 through 4.11.

Isoelectric point

As discussed, electrophoresing amphoteric molecules through a pH gradient results in isoelectric focusing; the molecules stop at the pH equal to their pI. The pI of an unknown protein can be estimated quickly by comparing it with standards with known pIs, as described for sizing in the preceding section. If the pH gradient is formed using soluble buffering species (ampholytes), the pH of the gel can be measured at desired points along the surface, using a pH electrode designed for use on moist surfaces.

1.6 Blotting

1.6.1 Transfer

For analysis based on antibody reactivity, the separated molecules need to be free of the electrophoresis matrix. This can be done by slicing the gel into segments and then eluting the sample into a buffer, but the process is slow and the resolution is low. A more efficient method uses a “blotting” technique. In blotting, the molecules separated on a slab gel are eluted through the broad face of the gel onto a membrane filter that binds the molecules as they emerge. The proteins (or nucleic acids) stay predominantly on the surface of the membrane, where they are accessible for detection.

The membrane materials used most frequently in blotting are nitrocellulose, various forms of modified and unmodified nylon, and polyvinylidene difluoride (PVDF). The choice of membrane depends on the type of analysis and characteristics of the detection system. Nitrocellulose is the most generally applicable; some nylons do not bind protein reliably. PVDF is often used when the bound protein will ultimately be analyzed by automated solid-phase protein sequencing.

The transfer of the sample from the gel to the membrane can be driven either by capillary flow of buffer or by transverse electrophoresis. The use of capillary flow to transfer DNA from agarose gels to nitrocellulose was first described by Southern (1975), hence the name *Southern blot*. Using the same method for transfer of RNA is called *Northern blotting*, and any blot transfer of proteins is called *Western blotting* for simple playful consistency of nomenclature.

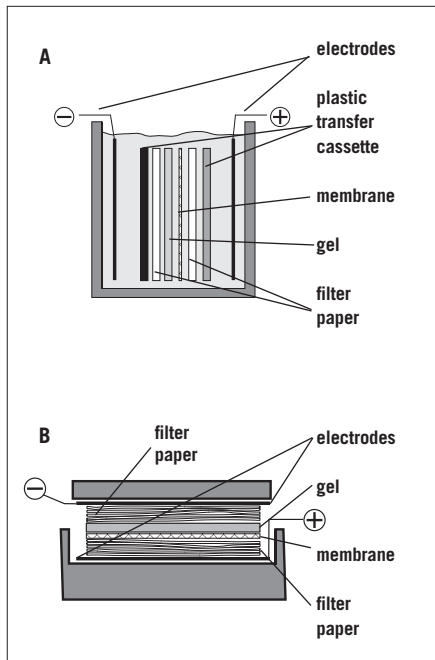

Fig 1.9. Electrophoretic blotting systems. Typically, these systems are used for electrophoretic transfer of proteins out of polyacrylamide gels. (A) Tank transfer. (B) Semidry transfer.

Transferring separated molecules electrophoretically is generally faster than capillary action, taking from 0.5 to 2 h. The gel containing separated proteins is placed next to a membrane in a cassette, which is then suspended in a tank of buffer between two electrodes. Applying a voltage to the electrodes moves the molecules out of the gel and onto the membrane (Fig 1.9a). The tank of buffer can be replaced by buffer-wetted pads of filter paper for “semidry” blotting (Fig 1.9b).

1.6.2 Detection

After transfer, proteins attached to the membrane can be detected either specifically with antibodies, or nonspecifically with various staining techniques. Highly sensitive nonradioactive immunodetection systems are available that locate the sites of specific antibody binding by chromogenic, fluorogenic, or chemiluminescent methods.

The results of the blot detection procedure can be analyzed as described previously for stained gels to extract quantitative information on size or amount of the detected target. Because an antibody detection system may not reveal any standards on the gel, however, it is sometimes necessary to use a staining method in addition to the specific probes for complete analysis. Prestained standard markers may be used or blotted protein standards can be visualized directly on the membrane by staining the membrane with Ponceau S. The position of the Ponceau S–stained bands must be marked with a permanent marker, as the dye washes out during the detection procedure.

1.7 Protocols in this manual

The following chapters of this manual describe SDS and native polyacrylamide electrophoresis, isoelectric focusing, and post-electrophoresis protein detection and gel analysis. The protocols in each chapter are examples of some of the most commonly used electrophoretic procedures and techniques for proteins. They are presented step-by-step so that a newcomer to electrophoresis can easily perform a separation or analysis with no additional reading or instruction.

1.8 References and bibliography

Andrews, A. T. *Electrophoresis: Theory, Techniques and Biochemical and Clinical Applications*, Oxford University Press, New York (1986).

Ausubel, F. M., *et al.*, eds. *Current Protocols in Molecular Biology*, Wiley-Interscience, New York (1995).

Hames, B. D., ed., *Gel Electrophoresis of Proteins: A Practical Approach* 3rd ed., Oxford University Press, New York (1998).

Southern, E. M. Detection of specific sequences among DNA fragments separated by gel electrophoresis. *J. Mol. Biol.* **98**, 503–517 (1975).

Chapter 2

Polyacrylamide gel electrophoresis

This chapter describes polyacrylamide gel electrophoresis of protein samples under denaturing and native conditions.

2.1 Equipment choices

There are many equipment options available for running polyacrylamide gels, each with characteristics particularly adapted to a limited set of applications. Choices include gel size and thickness, vertical or horizontal orientation, precast or lab-cast gels, speed and resolution requirements, application target, and cost considerations. Table 2.1 lists the instruments available from Amersham Biosciences with features for each.

Table 2.2 lists some of the parameters to consider when choosing a system.

Separations may be performed in a vertical or a flatbed system. Vertical systems are widely used and offer a great deal of flexibility with accessories. With simple casting units, gels can be poured with a choice of buffers in a variety of thicknesses to accommodate various sample types and sizes in both mini- and standard gel formats.

Horizontal flatbed systems using ultrathin gels polymerized on support films offer advantages over vertical systems: more-secure gel handling, convenience of ready-made gels and buffer strips that eliminate the need for large volumes of buffer, good cooling efficiency, automation, and the possibility of washing, drying, and rehydrating the gels.

2.2 Separating proteins on the basis of molecular weight: SDS gel electrophoresis

2.2.1 Introduction

In SDS polyacrylamide gel electrophoresis (SDS-PAGE) separations, migration is determined not by intrinsic electric charge of polypeptides but by molecular weight. Sodium dodecylsulphate (SDS) is an anionic detergent that denatures proteins by wrapping the hydrophobic tail around the polypeptide backbone. For almost all proteins, SDS binds at a ratio of approximately 1.4 g SDS per gram of protein, thus conferring a net negative charge to the polypeptide in proportion to its length. The SDS also disrupts hydrogen bonds, blocks hydrophobic interactions, and substantially unfolds the protein molecules, minimizing differences in molecular form by eliminating the tertiary and secondary structures. The proteins can be totally unfolded when a reducing agent such as dithiothreitol (DTT) is employed. DTT cleaves any disulphide bonds between cysteine residues. The SDS-denatured and reduced polypeptides are flexible rods with uniform negative charge per unit length. Thus,

Table 2.1. Equipment choices for polyacrylamide gel electrophoresis

Choices for vertical systems

Hoefer miniVE

Gel size: 8 × 9 cm
 Protein electrophoresis time: 1–2 h
 One piece to cast and run gels
 Accepts precast gels from most manufacturers
 Blotting module can be used in same unit



Hoefer SE 250 and SE 260 (mini vertical)

Gel size: 8 × 7 cm, 8 × 9.5 cm
 Protein electrophoresis time: 1–2 h
 Temperature control: Alumina plate and built-in heat exchanger
 Accepts precast gels from most manufacturers



Hoefer SE 600 (standard vertical)

Gel size: 14 × 16 cm
 Protein electrophoresis time: 3–5 h
 Temperature control: Built-in heat exchanger

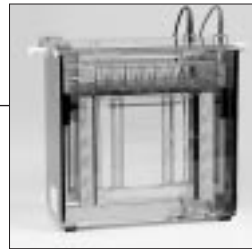

Hoefer SE 400 (standard vertical)

Gel size: 14 × 16 cm
 Protein electrophoresis time: 3–5 h



Choices for flatbed electrophoresis with precast gels

Multiphor II

Gel size: 25 × 11 or 18 × 0.5 cm
 Protein electrophoresis time: 1.5 h
 Temperature control: Ceramic heat exchanger
 High resolution separations at high voltages
 Wide range of precast gels available
 Precast buffer strips eliminate need for large volumes of buffer

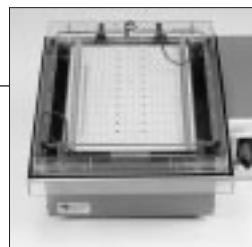

PhastSystem

Gel size: 43 × 50 × 0.45 mm
 Electrophoresis and staining time: 1.5 h
 Programmable power and temperature conditions for separation and staining
 Precast gels available: denaturing, native and isoelectric focusing



Table 2.2. Electrophoresis system selection

	Approx. gel size (w × l, cm)	Number of gels	Gel thickness (mm)	Number of samples/gel	Heat exchanger
<i>Vertical</i>					
Hoefer miniVE	8 × 7 8 × 9.5	1–2	0.75, 1, 1.5	5–18	N
Hoefer SE 250	8 × 7	1–2	0.75, 1, 1.5	5–18	Y
Hoefer SE 260	8 × 7 8 × 9.5	1–2	0.75, 1, 1.5	5–18	Y
Hoefer SE 600	14 × 15	1–4*	0.75, 1, 1.5	10–28	Y
Hoefer SE 400	14 × 15	1–2*	0.75, 1, 1.5	10–28	N
<i>Flatbed</i>					
Multiphor II	25 × 11 25 × 18	1	0.5	25–48	Y
PhastSystem	4.3 × 5.0	1–2	0.45	6–12	Y

*Optional divider plate doubles capacity to four gels (SE 600) or two gels (SE 400).

because molecular weight is essentially a linear function of peptide chain length, in sieving gels the proteins separate by molecular weight.

There are two types of buffer systems used in protein gel electrophoresis: continuous and discontinuous. A continuous system uses only one buffer for the tanks and the gel. In a discontinuous system, first developed by Ornstein (1964) and Davis (1964), a nonrestrictive large-pore gel called a *stacking gel* is layered on top of a separating (resolving) gel. The two gel layers are each made with a different buffer, and the tank buffers differ from the gel buffers.

In a discontinuous system, *protein mobility*—a quantitative measure of the migration rate of a charged species in an electric field—is intermediate between the mobility of the buffer ion of the same charge (usually negative) in the stacking gel (leading ion) and the mobility of the buffer ion in the upper tank (trailing ion). When electrophoresis is started, the ions and the proteins begin migrating into the stacking gel. The proteins concentrate in a very thin zone, called the *stack*, between the leading ion and the trailing ion. The proteins continue to migrate in the stack until they reach the separating gel. At that point, due to a pH or an ion change, the proteins become the trailing ion and “unstack” as they separate on the gel.

Although a continuous system is slightly easier to set up than a discontinuous system and tends to have fewer sample precipitation and aggregation problems, much greater resolution can be obtained with a discontinuous system. Only minimal concentration of the sample takes place with contin-

uous gels, and proteins form zones nearly as broad as the height of the original samples in the sample wells, resulting in much lower resolution.

Denaturing gel electrophoresis can resolve complex protein mixtures into hundreds of bands on a gel. The position of a protein along the separation lane gives a good approximation of its size, and, after staining, the band intensity is a rough indicator of the amount present in the sample. This simultaneous ability to estimate size and amount of a protein is useful in various applications: estimating purity, level of gene expression, immunoblotting, preparing for protein sequencing, and generating antibodies.

The discontinuous Laemmli system (Laemmli, 1970), a denaturing modification of Ornstein (1964) and Davis (1964), is the most widely used system for research protein electrophoresis today. The resolution in a Laemmli gel is excellent because the treated peptides are concentrated in a stacking zone before entering the separating gel. Other buffer systems can be used, for example the Tris™-tricine system of Schägger and von Jagow (1987) for resolution of polypeptides in the size range below M_r 10 000. For a detailed discussion and general reference on denaturing gel electrophoresis, consult the references listed at the end of this chapter.

The following protocol is for the use of the Laemmli SDS system in the Hoefer SE 600 standard vertical apparatus.

Proper laboratory safety and chemical-handling procedures should be observed in all electrophoresis work.

2.2.2 Stock solutions

Note: Use double-distilled water (ddH₂O), deionized water, or other high-quality water. Use the free base forms of Tris and glycine when making these solutions. “Tris-Cl” is used in these formulations to indicate that the pH of the solution is adjusted with concentrated HCl.

Caution: Acrylamide is a neurotoxin and should be handled with care.

Acrylamide solution	Final concentration	Amount
<i>(30% acrylamide, 0.8% bisacrylamide, 200 ml)</i>		
Acrylamide (FW 71.08)	30%	60 g
bisacrylamide (FW 154.17)	0.8%	1.6 g
ddH ₂ O		to 200 ml

Note: This will make a 30.8%T 2.7%_{C_{bis}} solution.
Store up to 3 mo at 4 °C in the dark.

4× Resolving gel buffer

(1.5 M Tris-Cl, pH 8.8, 200 ml)

Tris (FW 121.1)	1.5 M	36.3 g
ddH ₂ O		150 ml
HCl	to pH 8.8	
ddH ₂ O		to 200 ml

Store up to 3 mo at 4 °C.

4× Stacking gel buffer

Final concentration *Amount*

(0.5 M Tris-Cl, pH 6.8, 50 ml)

Tris (FW 121.1)	0.5 M	3.0 g
ddH ₂ O		40 ml
HCl	to pH 6.8	
ddH ₂ O		to 50 ml

Store up to 3 mo at 4 °C

10% SDS

SDS (FW 288.38)	10%	10 g
ddH ₂ O		to 100 ml

Store up to 6 mo at room temperature.

10% Ammonium persulphate (initiator)

Ammonium persulphate (FW 228.2)	10%	0.1 g
ddH ₂ O		to 1.0 ml

Prepare just prior to use; do not store.

Resolving gel overlay

(0.375 M Tris-Cl, 0.1% SDS, pH 8.8, 100 ml)

4× resolving gel buffer	1.5 M	25 ml
10% SDS	0.1%	1.0 ml
ddH ₂ O		to 100 ml

Store up to 3 mo at 4 °C.

2× Treatment buffer

(0.125 M Tris-Cl, 4% SDS, 20% v/v glycerol, 0.2 M DTT, 0.02% bromophenol blue, pH 6.8, 10 ml)

4× stacking gel buffer	0.125 M	2.5 ml
10% SDS	4%	4.0 ml
Glycerol	20%	2.0 ml
Bromophenol blue	0.02%	2.0 mg
Dithiothreitol (DTT; FW 154.2)	0.2 M	0.31 g
ddH ₂ O		to 10.0 ml

Store in 0.5 ml aliquots at -20 °C for up to 6 mo.

Tank buffer

(0.025 M Tris, 0.192 M glycine, 0.1% SDS, pH 8.3, 10 l)

Tris (FW 121.1)	0.025 M	30.28 g
Glycine (FW 75.07)	0.192 M	144.13 g
SDS	0.1%	10 g
ddH ₂ O		to 10 l

This solution can be made up directly in large reagent bottles, because it is not necessary to check the pH. Store at room temperature for up to 1 mo.

Water-saturated n-butanol

n-butanol	50 ml
ddH ₂ O	5 ml

Combine in a bottle and shake. Allow phases to separate. Use the top phase to overlay gels. Store at room temperature indefinitely.

Additional reagents

Protein standards (Table 2.3; Amersham Biosciences LMW marker kit #17-0446-01 for a molecular weight range of 14 400–94 000, and HMW-SDS marker kit #17-0615-01 for a molecular weight range of 53 000–212 000).

Tetramethylethylenediamine (TEMED)

2.2.3 Materials and equipment

- SE 600 vertical slab gel unit with casting stand
- 1.5- or 0.75-mm-thick combs and spacers
- Glass plates
- 50 ml and 125 ml side-arm flasks
- Transfer pipettes
- Pipettor capable of pipetting 1–20 μ l with long, narrow “gel-loading” pipette tips
- Water aspirator or vacuum pump with trap
- Boiling-water bath or 100 °C temperature block
- EPS 301 Power Supply (300 V)
- Magnetic stirrer
- Pipettes/graduated cylinders

Table 2.3. Protein standards with approximate molecular weights

Kit*	Protein	Molecular weight
LMW (17-0446-01)	Phosphorylase b	94 000
	Albumin	67 000
	Ovalbumin	43 000
	Carbonic anhydrase	30 000
	Trypsin inhibitor	20 100
	α -lactalbumin	14 400
HMW-SDS (17-0615-01)	Myosin	212 000
	α -2-Macroglobulin	170 000
	β -Galactosidase	116 000
	Transferrin	76 000
	Glutamate dehydrogenase	53 000
HMW Native (17-0445-01)	Thyroglobulin	669 000
	Ferritin	440 000
	Catalase	232 000
	Lactate dehydrogenase	140 000
	Albumin	67 000
Peptide Markers (80-1129-83)	Horse myoglobin peptides	16 949
		14 404
		10 700
		8 159
		6 214
		2 512

*From Amersham Biosciences

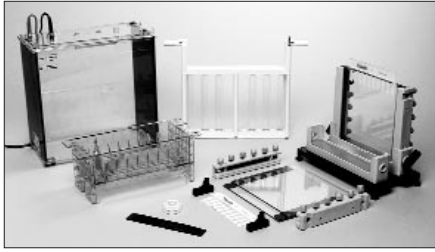

Fig 2.1. SE 600 Vertical Slab Gel Unit.

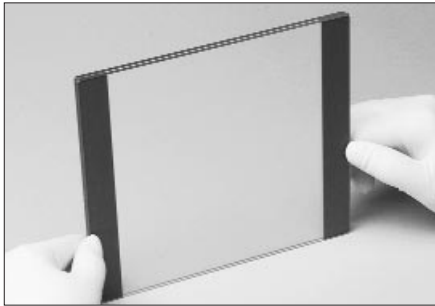

Fig 2.2a Inserting the spacer.

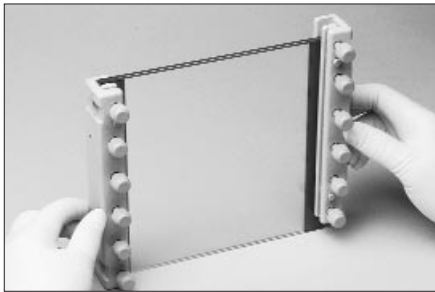

Fig 2.2b. Attaching the clamp.



Fig 2.2c. Properly assembled gel sandwich. Glass plates and spacer are flush.

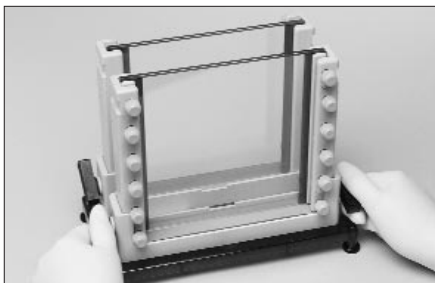

Fig 2.2d. Assembling the gel casting stand (step 1). The black cams are turned to seal the bottom surface of the sandwich into the casting stand gasket.

2.2.4 Procedure

Prepare the separating gel

1. Assemble the SE 600 vertical slab gel unit in the dual-gel casting stand. Use 1.5 mm or 0.75 mm spacers (Fig 2.2a–d).
2. In a 125 ml side-arm vacuum flask, mix either 40 ml (0.75 mm) or 80 ml (1.5 mm) of resolving gel solution (Table 2.4), leaving out the ammonium persulphate and the TEMED.

See Table 2.6 for recommended acrylamide concentrations.

3. Stopper the flask and apply a water vacuum for several minutes to deaerate the solution while swirling the flask (Fig 2.3).
4. Add the TEMED and ammonium persulphate and gently swirl the flask to mix, being careful not to generate bubbles.
5. Pipette the solution down the spacer into each sandwich to a level about 4 cm from the top. A 25 ml pipette works well for this step.

6. Fill a transfer pipette or syringe with water-saturated n-butanol (or water or resolving gel overlay). Position the pipette or needle at about a 45° angle with the point at the top of the acrylamide next to a spacer. Gently apply approximately 0.3 ml of n-butanol. Repeat on the other side of the slab next to the other spacer. The n-butanol will layer evenly across the entire surface after a minute or two. Repeat this process to overlay the second slab.

A very sharp liquid-gel interface will be visible when the gel has polymerized (Fig 2.4). This should be visible within 10–20 min. The gel should be fully polymerized in about 1 h.

7. After polymerization, tilt the casting stand to pour off the overlay and rinse the surfaces of the gels twice with resolving gel overlay.

Gels may be stored at this point. The stacking gel is cast later. Remove the n-butanol and add approximately 10 ml of 1× resolving gel overlay solution to the top of each sandwich, seal with plastic wrap, and store flat at 4 °C. Or store gels submerged flat in 1× resolving gel overlay at 4 °C for up to 1 wk.

8. Add approximately 1 ml of resolving gel overlay to each gel and allow the gels to sit while preparing the stacking gel.

Prepare the stacking gel

9. In a 50 ml side-arm vacuum flask, mix 10 ml (for 0.75-mm-thick gels) or 20 ml (for 1.5-mm-thick gels) of stacking gel solution (Table 2.4), leaving out the ammonium persulphate and the TEMED.

10. Deaerate as in step 3.

11. Add the ammonium persulphate and TEMED. Gently swirl the flask to mix.

Table 2.4. Resolving gel and stacking gel recipes for 1.5- and 0.75-mm-thick gels**Resolving gel solution (80 ml; 2 ea. 1.5-mm-thick SE 600/SE 400 gels)**

	Final gel concentration				
	5%	7.5%	10%	12.5%	15%
Acrylamide solution	13.3 ml	20 ml	26.7 ml	33.3 ml	40 ml
4× Resolving gel buffer	20 ml	20 ml	20 ml	20 ml	20 ml
10% SDS	0.8 ml	0.8 ml	0.8 ml	0.8 ml	0.8 ml
ddH ₂ O	45.5 ml	38.8 ml	32.1 ml	25.5 ml	18.8 ml
10% Ammonium persulphate*	400 µl	400 µl	400 µl	400 µl	400 µl
TEMED*	27 µl	27 µl	27 µl	27 µl	27 µl

*Added after deaeration (step 3).

Resolving gel solution (40 ml; 2 ea. 0.75-mm-thick SE 600/SE 400 gels)

	Final gel concentration				
	5%	7.5%	10%	12.5%	15%
Acrylamide solution	6.7 ml	10 ml	13.3 ml	16.7 ml	20 ml
4× Resolving gel buffer	10 ml	10 ml	10 ml	10 ml	10 ml
10% SDS	0.4 ml	0.4 ml	0.4 ml	0.4 ml	0.4 ml
ddH ₂ O	22.7 ml	19.4 ml	16.1 ml	12.8 ml	9.5 ml
10% Ammonium persulphate*	200 µl	200 µl	200 µl	200 µl	200 µl
TEMED*	13.3 µl	13.3 µl	13.3 µl	13.3 µl	13.3 µl

*Added after deaeration (step 3).

Stacking gel solutions (4% acrylamide; for two gels)

Gel thickness:	0.75 mm (10 ml total volume)	1.5 mm (20 ml total volume)
Acrylamide solution	1.33 ml	2.66 ml
4× Stacking gel buffer	2.5 ml	5 ml
10% SDS	0.1 ml	0.2 ml
ddH ₂ O	6 ml	12 ml
10% Ammonium persulphate*	50 µl	100 µl
TEMED*	5 µl	10 µl

*Added after deaeration (step 10).



Fig 2.3. Mixing the gel solution under vacuum (step 3). A water aspirator is a convenient choice for this procedure.

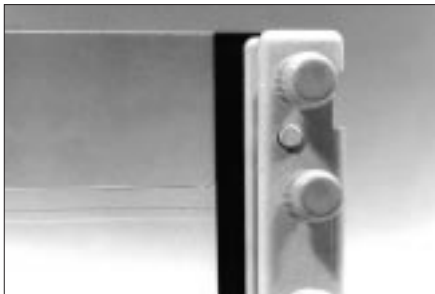

Fig 2.4. Polymerized resolving gel with n-butanol overlay.

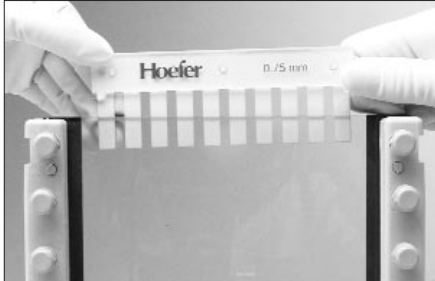

Fig 2.5. Inserting comb into stacking gel (step 13). Insert the comb at an angle to avoid trapping bubbles under the comb teeth.

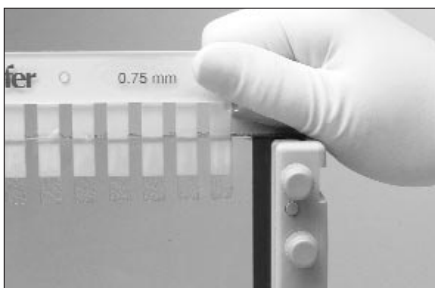

Fig 2.6. Removing comb from stacking gel (step 17). Do this gently to avoid damaging the well arms.

12. Pour off resolving gel overlay from the gel. Remove all liquid before proceeding.

13. Fill each sandwich with stacking gel solution and insert a comb into each sandwich, taking care not to trap any bubbles below the teeth of the comb (Fig 2.5).

Oxygen will inhibit polymerization, and bubbles will cause a local distortion in the gel surface at the bottom of the wells.

14. Allow the gel to sit for at least 30 min.

A very sharp interface will be visible when the gel has polymerized. This should be visible within 10–20 min. The gel should be fully polymerized after 1 h. In general, stacking gels should be cast just before use. The complete gel can be stored overnight at 4 °C, however, with little effect on resolution, if covered and the comb left in place.

Prepare the sample

15. Combine equal volumes of protein sample and 2× treatment buffer in a tube and place the tube in a boiling-water bath for 90 s. If using dry samples, add equal volumes of water and 2× treatment buffer and heat in a boiling-water bath for 90 s.

See ‘Troubleshooting’ section for more on sample preparation and how to ensure sharp bands. If the gels will be stained with Coomassie Blue, use a starting sample protein concentration of 10–20 mg/ml (i.e. 10–20 µg/µl). This will be diluted by the 2× treatment buffer to give 5–10 µg/µl. For complex mixtures (e.g. cell lysates), 50 µg of protein (5–10 µl of treated sample) per lane is recommended. For highly purified proteins, 0.5–5 µg per lane is usually adequate. Silver staining requires 10- to 100-fold less protein per lane.

16. Place samples briefly on ice until ready for use. The treated sample can be stored at 20 °C for 6 mo for future runs.

Note: The SDS may precipitate if tubes are left on ice for long periods of time.

Load the gels

17. Slowly remove the combs from the gels, raising the comb up to avoid disturbing the well dividers (Fig 2.6).

18. Rinse each well with tank buffer, invert the casting stand to drain the wells, and return the stand to an upright position.

19. Fill each well with tank buffer.

20. Using a pipettor with a long, thin tip (or a Hamilton™ syringe), gently load 5–10 µl of sample beneath the buffer in each well (Fig 2.7a). Load every well with the same volume of sample. If the well is not needed, load with 1× sample buffer containing standard protein or no sample.

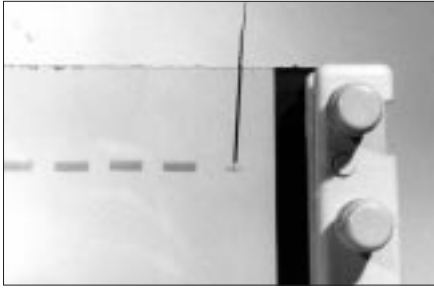

Fig 2.7a. Loading the sample (step 20). Use a very steady hand to load sample and maintain a sharp interface between the sample and the tank buffer.

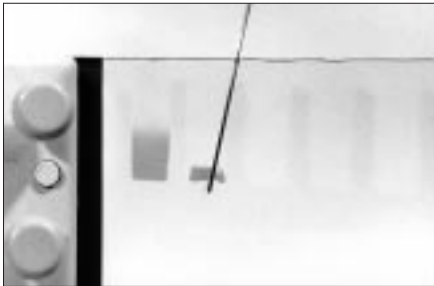

Fig 2.7b. The wrong way to load the sample. The well on the left was loaded too quickly and with too much volume, creating a large diffuse sample zone, while the well bottom on the right was damaged with the needle. Note that the right well arm is not straight; with large volumes this will decrease resolution.



Fig 2.8. Locking the upper buffer chamber in place.



Fig 2.9. The SE 600 fully assembled.

This procedure ensures that each well behaves the same during separation. If an adjacent well is left empty, the adjoining samples will tend to spread laterally during electrophoresis.

When adding the sample, be careful to maintain a sharp interface between the sample and the tank buffer (Fig 2.7a). Adding the sample too fast or erratically will lead to swirling and a diffuse loading zone. This will cause a loss of band sharpness (Fig 2.7b). Alternatively, the sample can be added and then overlaid with tank buffer. This is more time-consuming but, when performed carefully, minimizes contamination between wells and is particularly useful with radiolabelled samples.

21. If protein molecular weight standards are used, load one or two wells with 5–10 μl of the standard mixture. If the gel is to be stained with Coomassie Blue, this volume should contain 0.2–1 μg of each standard component. If the gel is to be silver stained, use 10–50 ng of each component.

Run the gel

22. Fill the lower buffer chamber with 4 l of tank buffer. Install the sealing gaskets on the upper buffer chamber and put it in place on the gel sandwiches. Remove the lower cams and cam the sandwiches to the bottom of the upper buffer chamber. Put the upper buffer chamber in place on the heat exchanger in the lower buffer chamber (Fig 2.8).

23. Adjust the height of the tank buffer in the lower buffer chamber until the sandwiches are fully immersed in buffer. If bubbles are trapped under the ends of the sandwiches, coax them away with a pipette.

24. Add a spin bar to the lower buffer chamber and center the chamber on a magnetic stirrer.

When the lower buffer is stirred, the temperature of the buffer remains uniform. This is important because uneven heating distorts the band pattern of the gel and leads to smiling.

25. Carefully fill the upper buffer chamber with tank buffer. Do not pour buffer into the sample wells, because it will wash the sample out.

26. Put the lid on the gel unit and connect it to the EPS 301 Power Supply. The cathode (black lead) is connected to the upper buffer chamber (Fig 2.9).

27. Turn on the power supply and adjust the voltage to 300 (so voltage is not limiting).

28. Adjust the current to 30 mA per 1.5-mm-thick gel and 15 mA per 0.75-mm-thick gel. Start the electrophoresis. The voltage should start at about 70–80 V, but will increase during the run. Keep a record of the voltage and current readings so that future runs can be compared and current leaks or incorrectly made buffers can be detected.

Under these conditions, the gel will take approximately 3–4 h to run. If it is more convenient to run the gel for a longer period (e.g. 8 h), reduce the

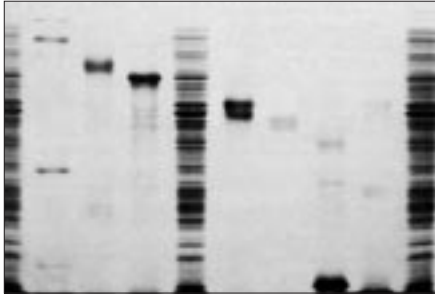

Fig 2.10. Coomassie Blue stained gel.

current to half—15 mA per 1.5-mm-thick gel; reduce the current to 7 mA per 1.5-mm-thick gel for 16 h (e.g. overnight).

29. When the tracking dye reaches the bottom of the gel, turn the power supply off and disconnect the power cables.

Disassemble the gel sandwiches

30. Remove the buffer and disassemble the sandwiches by gently loosening and sliding away both spacers. Slip an extra spacer or a Hoefer Wonder Wedge into the bottom edge and separate the plates. Carefully lift the gel into a tray of staining solution or fixative as outlined in the ‘Staining’ section of Chapter 4.

An example of a Coomassie Blue stained gel is shown in Figure 2.10.

2.3 Separating proteins on denaturing mini-gels

2.3.1 Introduction

Separating proteins with small gels is similar to running large gels except that volumes and separation times are considerably less. Like the large format, gels are cast either one or two at a time in the dual-gel caster, or in groups of four to 10 in a multiple caster. The combination of fast separations and small size makes mini-gels a very popular alternative to standard-size gels. Although the separation gel area is much less, generally resolution is adequate for most routine procedures. Large-format gels are still recommended when high resolution is paramount.

The Hoefer miniVE offers the convenience of both electrophoresis and electrotransfer in one compact instrument with only four major parts. The gel module is simultaneously a casting stand and an upper buffer chamber. An optional blot module is available, which folds into the miniVE tank. The SE 250 and SE 260 uses alumina plates to effectively remove heat from gel to buffer. There is also a cooling option.

The following protocols cast one or two gels at a time in the dual-gel caster. The Mighty Small dual-gel caster holds glass or glass/alumina plate gel sandwiches for simple casting of gels. The bottom of the sandwich is sealed against a rubber gasket by a cam action. Once the gel is set, the sandwiches are transferred to a Hoefer SE 250, SE 260, or miniVE mini-gel electrophoresis unit. Refer to Section 2.1, ‘Equipment choices,’ for guidelines on selecting an appropriate mini-gel unit.

The following procedure has been written for use with the Hoefer SE 250/ SE 260 mini-gel units. The Hoefer miniVE can also be used for running mini-gels. Its modular design incorporates a blotting system and is an appropriate choice when blotting follows electrophoresis. The procedure outlined below may also be followed when using the miniVE (the plates and volumes of solutions are the same); however, certain steps will not apply, such as the description of installing the plates on the unit. Side notes have been included when there are significant differences. Refer to instrument instructions for details.



Fig 2.11. Slide the sandwich into the clamp assembly with the notched plate facing inward and secure by tightening screws.

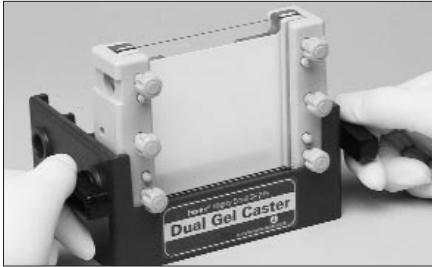
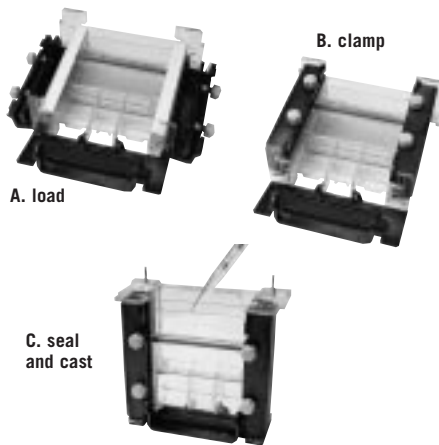

Fig 2.12. Place the clamp assembly in the casting cradle, screw side facing outward. In this position the gel will be visible through the rectangular glass plate. Insert a cam and seal the gel sandwich by turning both cams 180°.



For the miniVE unit, assemble the sandwich so the glass and spacers are aligned. Place the sandwich flat on the electrophoresis module with the notched plate to the back and the notch at the top. (A) Check to make sure that the glass plates and spacers are flush with the guide feet at the bottom of the module. While holding the sandwich in place, slide each clamp into position and gently tighten the screws. (B) Check the bottom-edge alignment of the sandwich and adjust the glass and spacers to ensure that the bottom edges are completely flush. Finish tightening the screws finger-tight. Raise the sealing plate into place until the tabs are engaged in the topmost notch. (C) Stand the caster upright or hang it from the miniVE chamber. Prepare gel solutions and cast the gel as per the SE 250/SE 260 instructions.

2.3.2 Materials and equipment

- Stock solutions from section 2.2.2
- 50 ml and 125 ml side-arm flasks
- Hoefer SE 250, SE 260, or miniVE mini-gel electrophoresis unit with plates, combs, and spacers
- SE 245 dual-gel casting stand
- Pipettes and pipettors
- EPS 301 Power Supply
- Precast gels can also be used and are available from several manufacturers

2.3.3 Procedure

Prepare the resolving gel

1. For each sandwich, choose one notched alumina (SE 250 or SE 260) or one notched glass plate (miniVE), one rectangular glass plate, and two spacers. Do not use chipped plates. Lay the notched plate on a flat surface and place one spacer along each edge extending along the side of the notch (on the “ear”). Fit a glass plate onto the spacers. The top of the T of the spacer rests along the side of the gel sandwich. On a flat surface, align the sides with the spacers and also the bottom.
2. Hold the sandwich by the flat sides firmly between your thumb and fingers. With the notched plate facing the clear back block, slide the sandwich into the clamp assembly, making sure the bottom edge of the sandwich rests on the flat surface. Insert a Hoefer Spacer-Mate™ to realign spacers that may have moved.
3. While holding the sandwich in place, secure it by tightening all six pressure bar screws finger-tight. (To prevent glass breakage, do not overtighten.)
4. Inspect the sandwich bottom to make sure that both plates and the spacers are aligned and even and that the bottom edge would rest on a flat surface. (The sandwich should protrude slightly below the back block; this position helps ensure a complete seal.) Adjust if necessary.
5. Place the clamp assembly in the casting cradle, screw side facing out. In this position the gel will be visible through the rectangular glass plate.
6. Insert a cam into the hole on each side of the casting tray so that the arrow (short end) points up. Seal the gel sandwich by turning both cams 180° so that the arrow points down. (Fig 2.12)

Pour the gel

7. Prepare the resolving gel solution in a 125 ml vacuum flask as described in Table 2.5 except omit the TEMED and ammonium persulphate.

Also, see Table 2.6 for recommended acrylamide concentrations.

Table 2.5. Resolving gel recipes for 1.5- and 0.75-mm-thick gels

(20 ml; 2 ea. 1.5-mm-thick, 8 × 7 cm SE 250 gels)

	Final gel concentration				
	5%	7.5%	10%	12.5%	15%
Acrylamide solution	3.3 ml	5 ml	6.7 ml	8.3 ml	10 ml
4× Resolving gel buffer	5 ml	5 ml	5 ml	5 ml	5 ml
10% SDS	0.2 ml	0.2 ml	0.2 ml	0.2 ml	0.2 ml
ddH ₂ O	11.4 ml	9.7 ml	8 ml	6.4 ml	4.7 ml
Ammonium persulphate*	100 µl	100 µl	100 µl	100 µl	100 µl
TEMED*	6.7 µl	6.7 µl	6.7 µl	6.7 µl	6.7 µl

*Added after deaeration (step 3).

(10 ml; 2 ea. 0.75-mm-thick, 8 × 7 cm SE 250 gels)

	Final gel concentration				
	5%	7.5%	10%	12.5%	15%
Acrylamide solution	1.67 ml	2.5 ml	3.3 ml	4.2 ml	5 ml
4× Resolving gel buffer	2.5 ml	2.5 ml	2.5 ml	2.5 ml	2.5 ml
10% SDS	0.1 ml	0.1 ml	0.1 ml	0.1 ml	0.1 ml
ddH ₂ O	5.7 ml	4.9 ml	4 ml	3.2 ml	2.4 ml
Ammonium persulphate*	50 µl	50 µl	50 µl	50 µl	50 µl
TEMED*	3.3 µl	3.3 µl	3.3 µl	3.3 µl	3.3 µl

*Added after deaeration (step 8).

(30 ml; 2 ea. 1.5-mm-thick, 8 × 10 cm SE 260/SE 280 or miniVE gels)

	Final gel concentration				
	5%	7.5%	10%	12.5%	15%
Acrylamide solution	5 ml	7.5 ml	10 ml	12.5 ml	15 ml
4× Resolving gel buffer	7.5 ml	7.5 ml	7.5 ml	7.5 ml	7.5 ml
10% SDS	0.3 ml	0.3 ml	0.3 ml	0.3 ml	0.3 ml
ddH ₂ O	17.1 ml	14.6 ml	12 ml	9.6 ml	7.1 ml
Ammonium persulphate*	150 µl	150 µl	150 µl	150 µl	150 µl
TEMED*	10 µl	10 µl	10 µl	10 µl	10 µl

*Added after deaeration (step 3).

(15 ml; 2 ea. 0.75-mm-thick, 8 × 10 cm SE 260/SE 280 or miniVE gels)

	Final gel concentration				
	5%	7.5%	10%	12.5%	15%
Acrylamide solution	2.5 ml	3.8 ml	5 ml	6.3 ml	7.5 ml
4× Resolving gel buffer	3.8 ml	3.8 ml	3.8 ml	3.8 ml	3.8 ml
10% SDS	0.15 ml	0.15 ml	0.15 ml	0.15 ml	0.15 ml
ddH ₂ O	8.6 ml	7.4 ml	6 ml	4.8 ml	3.6 ml
Ammonium persulphate*	75 µl	75 µl	75 µl	75 µl	75 µl
TEMED*	5 µl	5 µl	5 µl	5 µl	5 µl

*Added after deaeration (step 8).

Table 2.6. Recommended acrylamide concentrations for protein separation

(See Table 2.3 for appropriate standards.)

Separation size range (kD)	% acrylamide in resolving gel
36–205	5%
24–205	7.5%
14–205	10%
14–66*	12.5%
14–45*	15%

*The larger proteins fail to move significantly into the gel.

8. Stopper the flask and apply a vacuum for several minutes while swirling the flask.

9. Add the TEMED and ammonium persulphate and gently swirl the flask to mix, being careful not to generate bubbles.

10. Use a pipette to deliver the solution into one corner of the plate, taking care not to introduce any air pockets. Fill solution to 3 cm below the top of the rectangular glass plate. This height allows 1 cm of stacking gel below the wells.

11. Using a pipettor or syringe, add 100 μ l of water-saturated n-butanol (or water or diluted resolving gel buffer) near the spacer at the side of the gel sandwich to overlay the gel and prevent its exposure to oxygen. Allow gel to polymerize 1 h.

12. Pour off the overlay and rinse the gel sandwich with diluted resolving buffer. Rinse the gels twice with resolving gel overlay.

Gels may be stored at this point. The stacking gel (step 13) is cast later. Remove the n-butanol and add approximately 5.0 ml of 1 \times resolving gel overlay to the top of each sandwich, seal with plastic wrap, and store flat at 4 $^{\circ}$ C. Or store gels submerged flat in 1 \times resolving gel overlay at 4 $^{\circ}$ C for up to 1 wk.

Table 2.7. Stacking gel solutions (for two gels)

Gel thickness:	0.75 mm	1.5 mm
Acrylamide solution	0.44 ml	0.88 ml
4 \times Stacking gel buffer	0.83 ml	1.66 ml
10% SDS	33 μ l	66 μ l
ddH ₂ O	2.03 ml	4.06 ml
Ammonium persulphate*	16.7 μ l	33.4 μ l
TEMED*	1.7 μ l	3.3 μ l

*Added after deaeration.

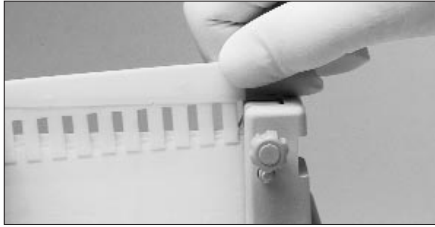

Fig 2.13. Add stacking gel and insert comb at an angle to avoid trapping bubbles.



Fig 2.14. Remove comb and wash wells to remove unreacted acrylamide.

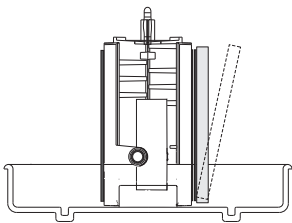

Fig 2.15a.

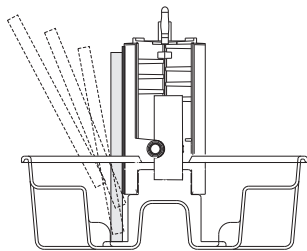

Fig 2.15b.

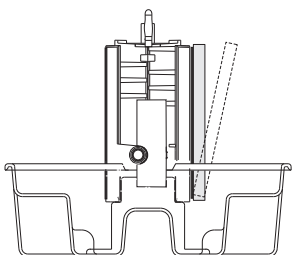

Fig 2.15c.

13. In a 50 ml side-arm flask, prepare stacking gel solution as described in Table 2.7 except omit the TEMED and ammonium persulphate.

Pour the stacking gel either while the sandwich is still in the gel caster or after it is transferred to the electrophoresis unit (see instructions with unit). The stacking gel should be cast just before use.

14. Stopper the flask and apply a vacuum for several minutes to deaerate the solution while swirling the flask.

15. Add the TEMED and ammonium persulphate and gently swirl the flask to mix, being careful not to generate bubbles.

16. Use a Pasteur pipette to apply the stacking gel over the resolving gel.

17. Introduce a comb (at a slight angle) into the sandwich, taking care not to trap air under the teeth (Fig 2.13). Allow gel to polymerize 1 h.

18. Remove the comb from the sandwich by carefully pulling on the comb while gently rocking it back and forth to break the suction (Fig 2.14). Rinse the wells with tank buffer.

19. Loosen the casting cradle pressure bar screws, tilt the gel sandwich forward, and lift it out.

The cutout in the top of the back plate facilitates easy removal of the sandwich.

Install the gel

20. To install the gel, use the following guidelines (Fig 2.15a-c).

I. SE 250

To install lab-cast or precast 10×8 cm plates, orient the sandwich so that the notched plate faces the gasket with the notch at the top. Set the bottom of the sandwich on the bottom of the lower buffer chamber and center the plate so that the gasket seals both sides (Fig 2.15a).

II. SE 260

To install a lab-cast or precast 10×10.5 cm gel sandwich, orient the sandwich so that the notched plate faces the gasket and the notch is at the top. Set the bottom of the sandwich on the supporting ledges on the bottom of the lower buffer chamber and center the plate so that the gasket seals both sides (Fig 2.15b).

If installing a self-cast or precast 10×8 cm gel sandwich, align the top of the plate with the top of the core. The bottom of the notched plate must cover the silicone rubber gasket (Fig 2.15c).

III. Precast gels (10×10 cm) using the SE 260

Precast gels for the SE 250, SE 260, and miniVE must have a notch in the back plate to seal along the sides of the sandwich and to make buffer contact at the top of the sandwich.

Precast gels on the miniVE

Position the cassette on the module so that the notched side is on the gasket and the wells are at the top of the module. Slide the clamps in place over the gel and tighten the screws.

Gels cast on the miniVE need not be transferred, because both casting and electrophoresis are performed using the same module. After the gel has been prepared, move the sealing plate to the half-open position (the lower notch).

Lower the module into the gel tank and fill both the upper and lower buffer chambers to the recommended levels with SDS electrophoresis buffer.

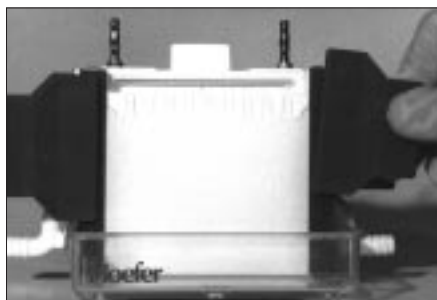

Fig 2.16. Place gel on the SE 250 upper buffer chamber.

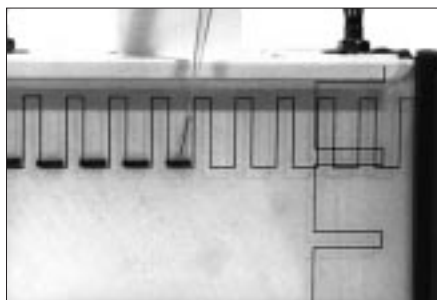

Fig 2.17. Use the supplied template as a guide to load samples.

Orient the sandwich so that the notched plate faces the gasket with the notches at the top. Set the bottom of the sandwich on the supporting ledges on the bottom of the lower buffer chamber and center the plates so that the gasket seals along both sides. Correct alignment is important to create a proper seal. Lightly press the sandwich against the gasket.

21. Lightly press the sandwich against the gasket and secure it to the core with one spring clamp on each side. Position the clamp so that the shorter rounded jaw edge fits into, but not past, the core groove and the longer jaws fits on the glass plate. Slide the clamps so that they are centered along the groove (Fig 2.16).

22. Repeat step 20 for the second sandwich or, if running only one gel, clamp a blank cassette or a plain glass plate on the unused side of the core to prevent a possible short circuit with the unused electrode. Do not fill this chamber with buffer if no gel sandwich is in place.

Prepare and load sample

23. Wet the well-locating decal (Fig 2.17) and let it adhere to the front of the glass plate so that the appropriate edge outlines the sample wells.

The decal will help with sample loading.

For precast gels or gels in miniVE, make a mark with a marking pen on the glass plate at the bottom of each well. This will make the wells more visible for loading when filled with buffer.

24. Fill the sample wells and each upper buffer chamber containing a gel sandwich with tank buffer.

One upper buffer chamber holds approximately 75 ml.

25. Underlay the sample into the wells using a fine-tipped microsyringe or pipettor with long, thin pipette tips (Fig 2.17).

Typical sample volumes range from 5 to 10 μ l, although this depends on the gel thickness. Use step 15 in the previous Laemmli SDS-PAGE section (2.2.4) as a guide to sample preparation.

Assemble the apparatus

26. Fill the lower buffer chamber with tank buffer. Ensure that the lower electrode, which runs along the bottom of the upper buffer chamber core, is completely submerged.

The SE 250 lower buffer chamber holds about 150 ml, and the SE 260 holds about 250 ml. The miniVE requires a minimum of 1 l for the lower buffer chamber.

27. Place the safety lid on the unit and plug the colour-coded leads into the jacks in the power supply (red to red, black to black).

28. Optional for the SE 250 and SE 260: Using a thermostatic circulator, begin circulating cold water or a chilled 50:50 mixture of water and ethylene glycol.

Run and process the gel

29. Run the gels under appropriate conditions. For example, run two 7 cm × 0.75 mm Laemmli gels approximately 1 h at 30 mA (15 mA per gel, constant current). Check band progress after 5 min and again after 30 min to monitor the position of the tracking dye.

Gels may be run at either constant current or constant voltage. A constant-current setting is traditionally used with a discontinuous buffer system so that the rate of electrophoretic migration remains unchanged throughout the run. Under these conditions voltage increases as the run proceeds. A lower current setting is recommended for higher resolution.

Run precast gels under the same current and voltage conditions as self-cast gels.

The run is complete when the tracking dye reaches the bottom of the gel.

30. When the tracking dye reaches the bottom of the gel, turn off the power supply, disconnect the leads, and remove the safety lid.

31. If coolant is circulating, stop the flow and disconnect the fittings or tubing.

32. Invert the core assembly and pour out the buffer, remove both clamps, and lift away gel sandwich(es) from the upper buffer chamber core.

33. Gently loosen and slide away both spacers. Slip an extra spacer or a Hoefer Wonder Wedge into the bottom edge (to prevent breaking the ears of the notched plates) and separate the plates. The gel may adhere to the alumina plate. Carefully lift the gel from the plate and lay it into a tray of stain or fixative as outlined in the 'Staining' section of Chapter 4.

A typical gradient gel is shown in Figure 2.18.

For the miniVE unit remove the gel module and dispose of the buffer. Unscrew the clamps and remove the gel sandwich.

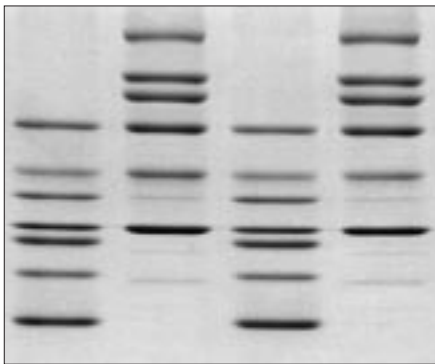

Fig 2.18. Mini-gels are capable of very high resolution separation. 1.5-mm-thick 5–20% gradient SDS-PAGE gel. High and low molecular weight standards stained with Coomassie Blue are shown. Separation conditions were 20 mA for 120 min.

2.4 Preparing linear pore-gradient gels

2.4.1 Introduction

Gradient gels, although more difficult to cast than single-concentration gels, resolve a much wider size range of proteins on a single gel. Furthermore, calculating molecular weights is simplified because, unlike single-concentration gels, the relationship between log size and mobility is linear over most of the fractionation range of the gel (see Fig 4.10, Chapter 4).

The protocol below describes casting one gradient gel at a time. Multiple gradient gels can be cast using a multiple-gel caster. Consult the manufacturer's instructions for casting several gradient gels at once.

2.4.2 Materials and equipment

- Gel solutions from section 2.2.2
- Sucrose
- Gradient maker (SG 50 for SE 600 and SG 15 for the SE 250 size mini-gels)
- Peristaltic pump capable of 1.6 ml/min
- Pump tubing with attached pipette tip
- Ring stand
- 125 ml side-arm flask
- Magnetic stirrer
- Small stir bar
- Electrophoresis unit (Hoefer SE 600 for standard-size gels or SE 250 for mini-gels) with spacers, combs, and glass plates
- Casting stand (SE 245 for mini-gels or SE 600 casting stand)
- EPS 301 Power Supply

2.4.3 Procedure

1. Set up the SE 245 or SE 600 gel casting stand with two glass sandwiches.
2. Connect a piece of tubing to the outlet tubing connector of the side-outlet gradient maker. Attach a micropipette tip to the other end of the tubing and, using a ring stand and clamp, position the tip at the top center of the sandwich (Fig 2.19). Use the clamp to hold the pipette tip firmly in place. The dispensing end of the pipette tip should be 0.5–1 mm inside the gel sandwich. Attach the tubing to the peristaltic pump.

The pump rate should be set so that casting takes 5–10 min.

3. In separate flasks mix all ingredients listed in Table 2.8 for the light and heavy running gradient gel solutions, including the ammonium persulphate. Do not add TEMED.

A 5–20% or 10–20% gradient gel is recommended.

Deaeration is not needed in this protocol. Once mixed, keep the heavy solution on ice to prevent polymerization. High-concentration acrylamide solutions may polymerize without the addition of TEMED once the ammonium persulphate has been added.

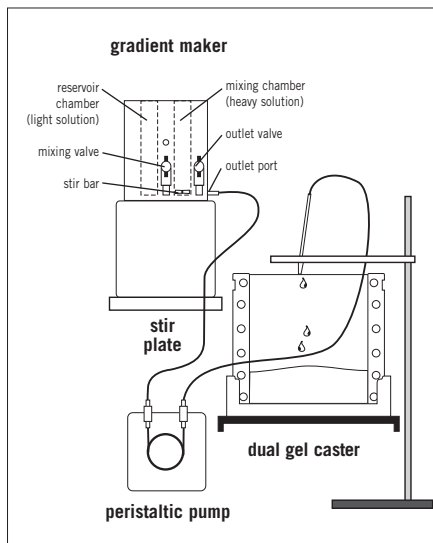

Fig 2.19. Setup for casting gradient gels one at a time. When casting from the top in a single-gel caster, the heavy solution enters first.

Table 2.8. Gradient gel solutions, part 1

Light solution

(5 ml one 1.5- or two 0.75-mm-thick SE 250 gels)	Final gel concentration				
	5%	7.5%	10%	12.5%	15%
Acrylamide solution	0.84 ml	1.25 ml	1.65 ml	2.1 ml	2.5 ml
4× Resolving gel buffer	1.25 ml	1.25 ml	1.25 ml	1.25 ml	1.25 ml
10% SDS	0.05 ml	0.05 ml	0.05 ml	0.05 ml	0.05 ml
ddH₂O	2.85 ml	2.45 ml	2 ml	1.6 ml	1.2 ml
10% Ammonium persulphate	45 µl	40 µl	32 µl	27 µl	20 µl
TEMED*	1.7 µl	1.7 µl	1.7 µl	1.7 µl	1.7 µl

*Added just before pouring gel.

Heavy solution

	Final gel concentration				
	10%	12.5%	15%	17.5%	20%
Acrylamide solution	1.65 ml	2.1 ml	2.5 ml	2.92 ml	3.3 ml
4× Resolving gel buffer	1.25 ml	1.25 ml	1.25 ml	1.25 ml	1.25 ml
10% SDS	0.05 ml	0.05 ml	0.05 ml	0.05 ml	0.05 ml
Sucrose	0.75 gm	0.75 gm	0.75 gm	0.75 gm	0.75 gm
ddH₂O	1.62 ml	1.17 ml	0.77 ml	0.35 ml	0 ml
10% Ammonium persulphate	25 µl	22 µl	10 µl	10 µl	10 µl
TEMED*	1.7 µl	1.7 µl	1.7 µl	1.7 µl	1.7 µl

*Added just before pouring gel.

Table 2.8. Gradient gel solutions, part 2*Light solution*

(10 ml one 0.75-mm-thick SE 600 gel or two 1.5-mm-thick SE 250 gels)

	Final gel concentration				
	5%	7.5%	10%	12.5%	15%
Acrylamide solution	1.67 ml	2.5 ml	3.3 ml	4.2 ml	5 ml
4× Resolving gel buffer	2.5 ml	2.5 ml	2.5 ml	2.5 ml	2.5 ml
10% SDS	0.1 ml	0.1 ml	0.1 ml	0.1 ml	0.1 ml
ddH₂O	5.7 ml	4.9 ml	4 ml	3.2 ml	2.4 ml
10% Ammonium persulphate	90 µl	80 µl	65 µl	55 µl	40 µl
TEMED*	3.3 µl	3.3 µl	3.3 µl	3.3 µl	3.3 µl

*Added just before pouring gel.

Heavy solution

	Final gel concentration				
	10%	12.5%	15%	17.5%	20%
Acrylamide solution	3.3 ml	4.2 ml	5 ml	5.8 ml	6.6 ml
4× Resolving Gel buffer	2.5 ml	2.5 ml	2.5 ml	2.5 ml	2.5 ml
10% SDS	0.1 ml	0.1 ml	0.1 ml	0.1 ml	0.1 ml
Sucrose	1.5 gm	1.5 gm	1.5 gm	1.5 gm	1.5 gm
ddH₂O	3.23 ml	2.33 ml	1.53 ml	0.70 ml	0 ml
10% Ammonium persulphate	50 µl	45 µl	20 µl	20 µl	20 µl
TEMED*	3.3 µl	3.3 µl	3.3 µl	3.3 µl	3.3 µl

*Added just before pouring gel.

Table 2.8. Gradient gel solutions, part 3

Light solution

(20 ml one 1.5- or two 0.75-mm-thick SE 600 gels)

	Final gel concentration				
	5%	7.5%	10%	12.5%	15%
Acrylamide solution	3.34 ml	5 ml	6.6 ml	8.4 ml	10 ml
4× Resolving gel buffer	5 ml	5 ml	5 ml	5 ml	5 ml
10% SDS	0.2 ml	0.2 ml	0.2 ml	0.2 ml	0.2 ml
ddH₂O	11.4 ml	9.8 ml	8 ml	6.4 ml	4.8 ml
10% Ammonium persulphate	180 µl	160 µl	130 µl	110 µl	80 µl
TEMED*	6.6 µl	6.6 µl	6.6 µl	6.6 µl	6.6 µl

*Added just before pouring gel.

Heavy solution

	Final gel concentration				
	10%	12.5%	15%	17.5%	20%
Acrylamide solution	6.6 ml	8.4 ml	10 ml	11.66 ml	13.2 ml
4× Resolving gel buffer	5 ml	5 ml	5 ml	5 ml	5 ml
10% SDS	0.2 ml	0.2 ml	0.2 ml	0.2 ml	0.2 ml
Sucrose	3 gm	3 gm	3 gm	3 gm	3 gm
ddH₂O	6.46 ml	4.66 ml	3.06 ml	1.40 ml	0 ml
10% Ammonium persulphate	100 µl	90 µl	40 µl	40 µl	40 µl
TEMED*	6.6 µl	6.6 µl	6.6 µl	6.6 µl	6.6 µl

*Added just before pouring gel.

Table 2.8. Gradient gel solutions, part 4*Light solution*

(40 ml two 1.5-mm-thick SE 600 gels)	Final gel concentration				
	5%	7.5%	10%	12.5%	15%
Acrylamide solution	6.68 ml	10 ml	13.3 ml	16.8 ml	20 ml
4× Resolving gel buffer	10 ml	10 ml	10 ml	10 ml	10 ml
10% SDS	0.4 ml	0.4 ml	0.4 ml	0.4 ml	0.4 ml
ddH₂O	22.8 ml	19.6 ml	16.1 ml	12.8 ml	9.6 ml
10% Ammonium persulphate	360 µl	320 µl	260 µl	220 µl	160 µl
TEMED*	13.2 µl	13.2 µl	13.2 µl	13.2 µl	13.2 µl

*Added just before pouring gel.

Heavy solution

	Final gel concentration				
	10%	12.5%	15%	17.5%	20%
Acrylamide Solution	13.2 ml	16.8 ml	20 ml	23.32 ml	26.6 ml
4× Resolving Gel Buffer	10 ml	10 ml	10 ml	10 ml	10 ml
10% SDS	0.4 ml	0.4 ml	0.4 ml	0.4 ml	0.4 ml
Sucrose	6 gm	6 gm	6 gm	6 gm	6 gm
ddH₂O	12.92 ml	9.32 ml	6.12 ml	2.8 ml	0 ml
10% Ammonium Persulphate	200 µl	180 µl	80 µl	80 µl	80 µl
TEMED*	13.2 µl	13.2 µl	13.2 µl	13.2 µl	13.2 µl

*Added just before pouring gel.

Table 2.9. Recommended volume per chamber for casting a single gradient gel

	Thickness 0.75 mm	1.5 mm
SE 250	1.7 ml	3.5 ml
SE 600	7 ml	14 ml

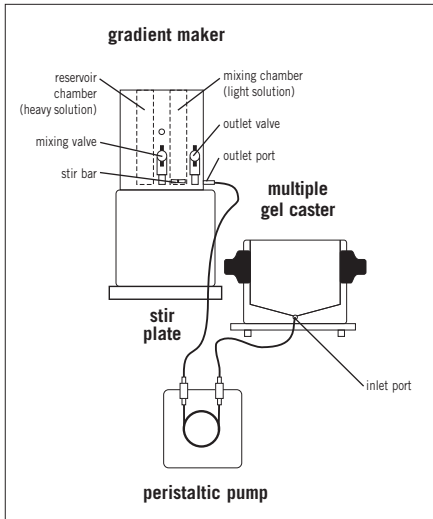

Fig 2.20. Setup for casting gradient gels using a multiple-gel caster. When using a multiple-gel caster, the light solution enters first.

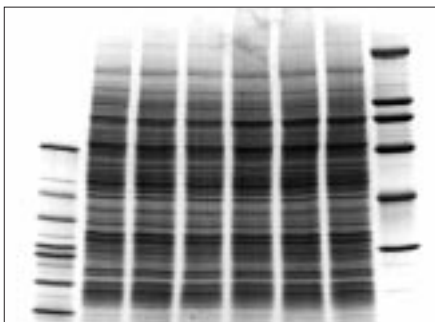

Fig 2.21. 5–20% acrylamide gradient gel. 0.75-mm-thick SDS gel was separated overnight at 4 mA and stained with Coomassie Blue. Outside lanes contain protein standards.

4. Add the TEMED and gently swirl the flasks to mix.

Note: Alternatively, add gel solution to the gradient maker before adding TEMED. Just before opening the outlets, add 0.33 μ l of TEMED per milliliter of gel solution and mix by drawing in and out of a disposable plastic pipette. If this technique is used, a large volume of heavy and light solutions can be prepared in advance and dispensed into the gradient maker for each individual gel. This is useful when casting several gels individually without using a multiple-gel caster.

5. Pour the heavy solution into the chamber closest to the outlet (mixing chamber) of the gradient maker (Fig 2.19). See Table 2.9 for recommended volumes per chamber. Add a small magnetic stir bar. See also note in step 4 above.

The heavy solution enters the gel sandwich first when casting gels one at a time from the top.

When casting gels in a multiple-gel caster, the gels fill through the inlet at the bottom, and the light solution must enter first. Thus, with multiple-gel casters, the light solution is placed in the mixing chamber (Fig 2.20).

6. Open the valve between the two chambers and allow a small amount of the heavy solution to flow through the channel to, but not into, the bottom of the reservoir chamber. Close the valve.

7. Pour the light solution into the reservoir chamber. See also note in step 4 above.

8. Place the gradient maker on a magnetic stirrer and begin stirring.

9. Turn on the pump and open the outlet valve.

10. Once the tubing has filled with a few centimeters of heavy gel solution, open the valve between the two chambers. Continue to pump until all the liquid is in the sandwich.

11. Overlay the gel with 0.3 ml of water-saturated n-butanol and allow the gel to polymerize. Continue procedure with casting the stacking gel in step 9 in section 2.2.4 for standard-size gels or step 12 of section 2.3.3 for mini-gels. Typical gradient gels are shown in Figures 2.18 and 2.21.

2.5 Native gel electrophoresis

Under native PAGE conditions, polypeptides retain their higher-order structure and often retain enzymatic activity and interaction with other polypeptides. The migration of proteins depends on many factors, including size, shape, and native charge. The resolution of nondenaturing electrophoresis is generally not as high as that of SDS-PAGE, but the technique is useful when the native structure or enzymatic activity of a protein must be assayed following electrophoresis. One straightforward approach to native electrophoresis is to omit the SDS and reducing agent (DTT) from the standard Laemmli SDS protocol. Prepare the gels as described above, but do not put SDS or DTT in the sample buffer, do not heat the samples, and prepare the gel and tank buffer solutions without SDS. For more information on native PAGE under different conditions, consult Hames, 1998.

2.6 Separating proteins by flatbed SDS-PAGE

2.6.1 Introduction

Flatbed systems using ultrathin gels polymerized on support films offer advantages over vertical systems: simpler handling; convenience of ready-made gels and buffer strips (which eliminates the need for preparing large buffer volumes); good cooling efficiency; possibility of washing, drying, and rehydrating the gels; and the possibility of automation.

Amersham Biosciences offers the Multiphor II system and Phast-System for running gels in a flatbed format (see Table 2.1 and 2.2 in Section 2.1). The Multiphor II system provides excellent resolution and relatively rapid separations in a large-format gel. It allows cooling of ultrathin gels efficiently and uniformly, through a ceramic heat exchanger, for improved resolution and speed at high voltages. The PhastSystem automates both the running and staining of precast mini-gels.

The availability of a wide range of ultrathin gels makes running flatbed gels very convenient. Table 2.10 lists the precast gels available for the Multiphor II system.

The following procedure outlines the use of the Multiphor II unit (Fig 2.22) for separating proteins on a precast SDS 7.5% acrylamide gel.



Fig 2.22. Multiphor II Flatbed Electrophoresis System.

2.6.2 Materials and equipment

- Kerosene or light paraffin oil
- ExcelGel™ SDS Homogeneous 7.5% (precast SDS-polyacrylamide gel on plastic backing)
- ExcelGel SDS buffer strips
- Multiphor II Electrophoresis unit
- MultiTemp™ III Thermostatic Circulator
- EPS 3501 or EPS 1001 Power Supply
- Multiphor Buffer Strip Positioner (optional)

Table 2.7. Precast acrylamide gels and buffer kits for Multiphor II System

Product	Application*	Sample no./gel	Volume (µl)	Buffer
ExcelGel SDS Gradient, 8–18%	strip	26	1–40	A
ExcelGel SDS Homogeneous				
7.5%	well	25	5–17	A
12.5%	well	25	5–17	A
15%	well	25	5–17	A
ExcelGel SDS buffer strips (anode and cathode)				B, C
CleanGel™ SDS and Native PAGE				
25S	well	25	5–17	
36S	well	36	5–7	
48S	well	48	8	
CleanGel Buffer Kits				
SDS, pH 8.0				
Native, pH 5.5				
Native, pH 8.9				
Ampholine PAGplate IEF				
pH 3.5–9.5	strip	26–52	1–40	
pH 4.0–6.5	strip	26–52	1–40	
pH 5.5–8.5	strip	26–52	1–40	
pH 4.0–5.0	strip	26–52	1–40	
CleanGel Dry IEF	strip	26–52	1–40	
Immobiline DryPlate IEF				
pH 4.0–7.0	strip	26–52	1–40	
pH 4.2–4.9	strip	26–52	1–40	
pH 4.5–5.4	strip	26–52	1–40	
pH 5.0–6.0	strip	26–52	1–40	
pH 5.6–6.6	strip	26–52	1–40	

*Application refers to the method of applying the sample on the gel. The ExcelGel Homogeneous gels and CleanGel SDS and Native gels are made with preformed wells for applying samples. Others (labelled *strip*) require an application strip or sample application pieces for applying samples.

A: Tris/HAc pH 6.4
 B: Tris/HAc pH 5.6
 C: Tris/tricine pH 7.1

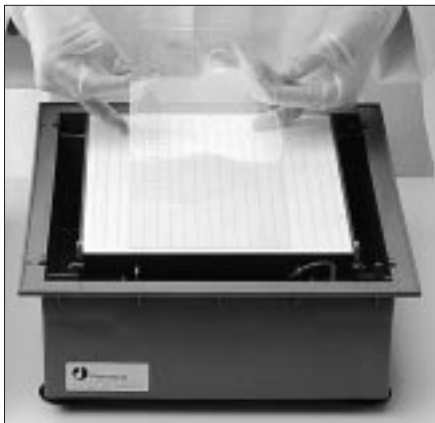

Fig 2.23. Placing the gel on the Multiphor II cooling plate.

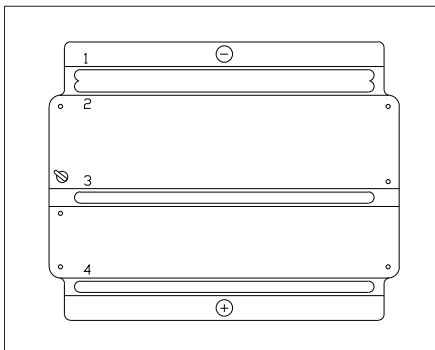

Fig 2.24a. Multiphor II Buffer Strip Positioner.



Fig 2.24b. Place the appropriate colour-coded buffer strips along the anodic and cathodic ends of the gel.

2.6.3 Procedure

Instrument and gel preparation

1. Connect the Multiphor II electrophoresis unit to the MultiTemp III thermostatic circulator and set the temperature to 15 °C. Turn on the thermostatic circulator 10 min before starting the analysis.
 2. Pipette 1–2 ml of kerosene or light paraffin oil onto the cooling plate of the electrophoresis unit.
 3. Remove the precast gel from the foil package by cutting away the edges of the foil. Markings on the plastic cover of the gel indicate the direction of electrophoresis.
- Note:* Gels without preformed wells also have a notch at the lower-left corner of the film that identifies the anodic (+) end.
4. Orient the gel according to these markings and remove the gel cover. Carefully lower the gel onto the cooling plate, allowing the kerosene or oil to spread evenly underneath the gel. Make sure no bubbles are trapped beneath the gel (Fig 2.23).

Apply the buffer strips

5. Place the two colour-coded buffer strips on the gel. Peel back the foil on the colourless cathodic (–) ExcelGel SDS buffer strip. Place the buffer strip with the smooth, narrow face downward along and in complete contact with the cathodic edge of the SDS gel. Avoid trapping air bubbles between the gel and the buffer strip.

Note: The Multiphor II Buffer Strip Positioner (80-6442-90) simplifies buffer strip placement and promotes straighter runs by ensuring precise positioning. Please see the instructions (80-6443-66) for guidelines on the use of this product (Fig 2.24a).

If the buffer strip breaks, piece it together on the gel.

6. Repeat step 5 with the orange anodic (+) ExcelGel buffer strip, placing it along the anodic edge of the SDS gel (Fig 2.24b).

Apply the sample and run the gel

7. Pipette the samples and/or standards into the wells of the gel. Use 5–20 µl sample volumes.
8. Place the electrode holder and align the electrodes over the center of the buffer strips. Lower the electrode holder so that the electrodes rest on top of the buffer strips. Connect the two electrodes to the base unit and place the lid on the unit.
9. Connect the leads to the power supply. Set the power supply to 600 V, limiting the current at 50 mA and the power at 30 W. Run the gel for 1.5 h.
10. Turn off the power supply when the bromophenol blue dye front has reached the anodic buffer strip. Disconnect the leads. Take the lid off the unit and remove the electrode holder. Remove and discard the buffer strips.
11. Lift off the gel and place it in a staining tray and proceed with desired staining method as outlined in the ‘Staining’ section of Chapter 4.

2.7 Troubleshooting

Vertical slab gels

Many factors affect the quality of electrophoretic separations, including: instrument assembly, preparation of the gel and sample buffers, gel casting, the nature of the sample and its preparation, and run conditions. Some difficulties that may be encountered during the protocol and possible explanations and solutions are described in this section.

Problem	Possible cause	Remedy
Gel solution leaks out of sandwich during casting	Plates and spacers misaligned	Realign as shown in Figure 2.2c
	Rubber gasket not seated properly	Check that it is seated flat
	Glass plates are chipped at edge	Use unchipped plates
Gels fail to polymerize, or polymerize incompletely along spacers and sealing surfaces	Solution temperature too low	Bring all refrigerated gel solutions to room temperature prior to use. It can help to warm the gel solution to 20–25 °C after deaeration and allow it to polymerize at or slightly above room temperature.
	Oxygen concentration too high	Deaerate gel solution 5–10 min with at least a water aspirator
	Insufficient or degraded catalyst	Check the ammonium persulphate for freshness. Fresh ammonium persulphate will crackle when water is added; if it doesn't, use a fresh bottle. Make new solutions daily. If the polymerization problem persists, increase the ammonium persulphate and TEMED concentration by 50%. Increasing the catalyst concentration is particularly useful when working with low acrylamide concentrations.
Sample wells distorted, causing distorted protein bands	Air bubbles trapped under comb	Remove air bubbles if present
	Unreacted acrylamide continued to polymerize after comb was removed	Rinse wells with tank buffer immediately after the comb is removed
Dye front curves up (smiles) at the edges	Gel is hotter in the middle than at the edges (the spacers act as heat sinks, lowering the temperature at the edge of the gel)	Use active temperature control of the SE 600 and completely submerge the gel sandwich in the stirred buffer
	Temperature too high	Reduce power settings
Dye front curves down (frowns) at the edges	Air bubbles trapped between glass plates at bottom of gel sandwich can be large enough to block current flow and produce a localized frown	Remove air bubbles if present
	Gel next to the spacers was not fully polymerized; current leaked down the edges of gel, producing a localized frown at edge	Degas solution or increase ammonium persulphate and TEMED concentration by 50%
	Upper buffer chamber sealing gasket pinched closed at center	Check for proper installation

Problem	Possible cause	Remedy
Protein bands fuzzy or poorly resolved	Sample volume too high	Load sample in less volume, as a tight layer in the bottom of well. Height of the stacking gel beneath the well should be at least two times the height of the sample in the well.
	Samples diffused out of well	Start electrophoresis immediately after loading samples
	Gel acrylamide concentration too low (proteins that separate near dye front are usually less well resolved than those farther up the gel)	Tailor gel concentration to produce optimal resolution. (Table 2.6). Use gradient gel to increase sharpness of lower MW bands.
	Sample is degraded	Keep sample on ice until mixed with SDS sample buffer and heat in 70–100 °C water bath for no more than 3 min
Run takes longer than usual	Buffers (tank or gel) too concentrated or at wrong pH	Remake solutions
Stained material concentrates at dye front	%T too low to fractionate the sample proteins, or proteins are degraded to the point where they are too small to resolve	Increase % acrylamide
Stained material concentrates at top of resolving gel	%T too high, and proteins cannot penetrate the matrix	Decrease % acrylamide
	Insoluble precipitates in sample	Some proteins precipitate upon heating at 100 °C (seen as staining and protein smearing at top of resolving gel). Heat at lower temperature (60–70 °C).

Flatbed electrophoresis

No current at start of run	Electrode cable not plugged in	Ensure that all cables are properly connected
Dye front curves up (smiles) at one edge	Cathodic buffer strip does not contact gel at one edge	Ensure that cathodic buffer strip is centered and covers entire width of gel
Dye front curves up (smiles) at both edges	Inadequate cooling	Ensure that thermostatic circulator is connected to Multiphor II unit and functioning correctly
Dye front is irregular	Buffer strips or ExcelGel are old	Ensure that expiration dates on buffer strips and ExcelGel have not elapsed
	Bubbles under buffer strip	Ensure that buffer strips are placed firmly on gel with no air bubbles trapped beneath
Buffer strip slides out from under electrode	Incorrect electrode placement	Ensure that electrodes are aligned over center of buffer strips before lowering electrode holder

2.8 References and bibliography

Davis, B. J. Disc electrophoresis-II: Method and application to human serum proteins. *Ann. N.Y. Acad. Sci.* **121**, 404–427 (1964).

Dunn, M. J. *Gel Electrophoresis: Proteins*. Bios Scientific Publishers Limited, Oxford, United Kingdom (1993).

Gallagher, S., and Smith, J. A., One-dimensional gel electrophoresis of proteins. In *Current Protocols in Molecular Biology Unit 10.2* (Ausubel, F. A. *et al.*, eds.), Wiley-Interscience, New York (1995).

Görg, A., *et al.*, *Biochem. Biophys. Methods* **3**, 273–284 (1980).

Hames, B. D., ed., *Gel Electrophoresis of Proteins: A Practical Approach 3rd ed.*, Oxford University Press, New York (1998).

Shi, Q. One-dimensional polyacrylamide gel electrophoresis. In *Gel Electrophoresis of Proteins: A Practical Approach 3rd ed.* (Hames, B. D., ed.), Oxford University Press, New York, pp. 1–52 (1998).

Laemmli, U. K. Cleavage of structural proteins during the assembly of the head of bacteriophage T4. *Nature* **227**, 680–685 (1970).

Ornstein, L. Disc electrophoresis-I: Background and theory. *Ann. N.Y. Acad. Sci.* **121**, 321–349 (1964).

Schägger, H., and von Jagow, G. *Anal. Biochem.* **166**, 368–379 (1987).

Westermeier, R. *Electrophoresis in Practice 2nd ed.* VCH, Weinheim, Germany (1997).

Chapter 3

Isoelectric focusing of proteins

3.0 Introduction

Isoelectric focusing (IEF) is an electrophoretic method that separates proteins according to their *isoelectric points* (pI). Proteins are amphoteric molecules; they carry either positive, negative, or zero net charge, depending on their amino acid composition and the pH of their surroundings. The net charge of a protein is the sum of all the negative and positive charges of its amino acid side chains and amino- and carboxyl-termini. The isoelectric point is the specific pH at which the net charge of the protein is zero. Proteins are positively charged at pH values below their pI and negatively charged at pH values above their pI (Fig 3.1).

The presence of a pH gradient is critical to the IEF technique. In a pH gradient, under the influence of an electric field a protein will move to the position in the gradient where its net charge is zero. A protein with a positive net charge will migrate toward the cathode, becoming progressively less positively charged as it moves through the pH gradient until it reaches its pI. A protein with a negative net charge will migrate toward the anode, becoming less negatively charged until it also reaches zero net charge. If a protein should diffuse away from its pI, it immediately gains charge and migrates back to its isoelectric position. This is the *focusing* effect of IEF, which concentrates proteins at their pIs and separates proteins with very small charge differences. Because the degree of resolution is determined by electric field strength, IEF is performed at high voltages (typically in excess of 1 000 V). When the proteins have reached their final positions in the pH gradient, there is very little ionic movement in the system, resulting in a very low final current (typically below 1 mA).

One method for generating pH gradients in IEF gels relies on carrier ampholytes. *Carrier ampholytes* are small, soluble, amphoteric molecules with a high buffering capacity near their pI. Commercial carrier ampholyte mixtures comprise hundreds of individual polymeric species with pIs spanning a specific pH range. When a voltage is applied across a carrier ampholyte mixture (Fig 3.2), the carrier ampholytes with the lowest pI (and the most negative charge) move toward the anode, and the carrier ampholytes with the highest pI (and the most positive charge) move toward the cathode. The other carrier ampholytes align themselves between the extremes, according to their pIs, and buffer their environment to the corresponding pH. The result is a continuous pH gradient.

IEF can be run in either a native or a denaturing mode. Native IEF is the more convenient option, as precast native IEF gels are available in a variety of pH gradient ranges. This method is also preferred when native protein is required, as when activity staining is to be employed. The use of native IEF, however, is often limited by the fact that many proteins are

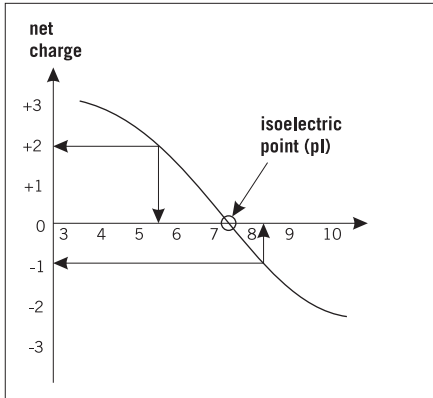

Fig 3.1. Net charge on a protein as a function of pH. In this example the protein has a net charge of +2 at pH 5.5, 0 at pH 7.5 (the isoelectric point), and -1 at pH 8.5.

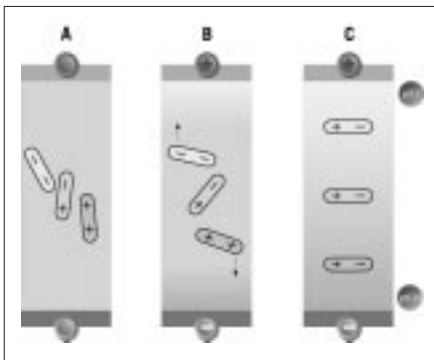

Fig 3.2. Creating a carrier ampholyte pH gradient. (A) No voltage applied. (B) Ampholytes and proteins move by electrophoresis when charged. (C) At isoelectric pH, ampholytes and proteins are focused.

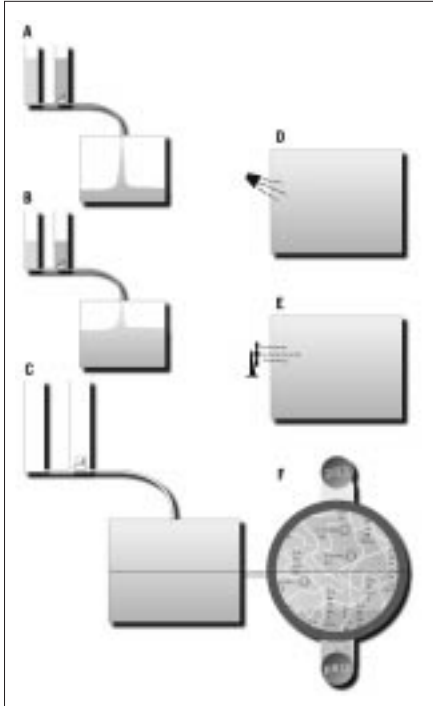

Fig 3.3. Creating an immobilized pH gradient. (A, B, C) A gradient of acrylamido buffers in an acrylamide solution is cast into a slab gel that is crosslinked to a plastic support film. (D) The gel is washed to remove polymerization byproducts. (E) The gel is dried for storage. (F) The pH at any point in the gel is determined by the mixture of buffers crosslinked into the gel at that site.

not soluble at low ionic strength or have low solubility close to their isoelectric point. In these cases, denaturing IEF is employed. Urea is the denaturant of choice, as this uncharged compound can solubilize many proteins not otherwise soluble under IEF conditions. Detergents and reducing agents are often used in conjunction with urea for more-complete unfolding and solubilization. Urea is not stable in aqueous solution, so precast IEF gels are not manufactured with urea. Dried precast gels are a convenient alternative; they have been cast, rinsed, and dried and can be rehydrated with urea, carrier ampholytes, and other additives before use.

Although useful, carrier ampholytes have some limitations. Because the carrier ampholyte-generated gradient is dependent on the electric field, it breaks down when the field is removed. The pH gradients are also susceptible to gradient drift (or cathodic drift), a phenomenon in which there is a gradual decrease in pH at the cathodic (–) end of the gel and a flattening out of the pH at the anodic (+) end. For this reason it is important to not overfocus the protein, because cathodic drift will increase over time. There can be significant batch-to-batch and company-to-company variations in the properties of carrier ampholytes, which limits the reproducibility of focusing experiments. Another problem encountered with carrier ampholytes is their tendency to bind to the sample proteins, which may alter the migration of the protein and render the separation of carrier ampholytes from the focused protein difficult.

Acrylamido buffers are an alternative means to form pH gradients that circumvent most of the limitations of carrier ampholytes. Chemically, they are acrylamide derivatives of simple buffers and do not exhibit amphoteric behavior. The acrylic function of an acrylamido buffer co-polymerizes with the gel matrix and, by pouring a gel that incorporates an appropriate gradient of acrylamido buffers, an *immobilized pH gradient (IPG)* is formed (Fig 3.3). The protein sample can be applied immediately (no prefocusing is needed). The pH gradient is stable and does not drift in an electric field. Additionally, the gels are not susceptible to cathodic drift, because the buffers that form the pH gradient are immobilized within the gel matrix. Acrylamido buffers are available from Amersham Biosciences as individual Immobiline™ species with a specific pK value (or optimum pH buffering range), suitable for casting gradients from pH 3–10. Because reproducible linear gradients with a slope as low as 0.01 pH units/cm can separate proteins with pI differences of 0.001 pH units, the resolution possible with immobilized pH gradient gels is 10–100 times greater than that obtained with carrier ampholyte-based IEF.

IEF is best performed in a flatbed electrophoresis apparatus. This type of apparatus allows very effective cooling, which is necessary due to the high voltages employed for IEF. Amersham Biosciences offers a variety of precast gels for IEF, including ready-to-use carrier ampholyte gels, dried IPG gels, and dried acrylamide gels ready for reswelling in a mixture of carrier ampholytes and any other additives desired, such as detergent and denaturants.

Table 3.1 lists the pH ranges available for these gels.

Table 3.1. Precast IEF gels for Multiphor II Flatbed Electrophoresis System

Gel type

Ampholine™ PAGplate IEF

pH 3.5–9.5
pH 4.0–6.5
pH 5.5–8.5
pH 4.0–5.0

CleanGel Dry IEF

Immobiline DryPlate IEF

pH 4.0–7.0
pH 4.2–4.9
pH 4.5–5.4
pH 5.0–6.0
pH 5.6–6.6

For all gels: sample volume, 1–40 µl; number of samples/gel, 26–52; samples are applied either by application strips or pieces.

3.1 Native isoelectric focusing

The following protocol separates proteins under native conditions over a range from pH 3.5 to pH 9.5 on an Ampholine PAGplate pH 3.5–9.5 precast IEF gel.

3.1.1 Solutions

IEF anode solution	Final concentration	Amount
<i>(1 M H₃PO₄, 100 ml)</i>		
Concentrated H ₃ PO ₄ (phosphoric acid 14.7 M)	1 M	6.8 ml
ddH ₂ O		to 100 ml
Store up to 6 mo at room temperature.		
IEF cathode solution		
<i>(1 M NaOH, 100 ml)</i>		
NaOH (sodium hydroxide FW 40.00)	1 M	4.0 g
ddH ₂ O		to 100 ml
Store up to 1 wk at room temperature.		

3.1.2 Materials and equipment

- IEF anode solution (1 M H₃PO₄)
- IEF cathode solution (1 M NaOH)
- Kerosene or light paraffin oil
- Ampholine PAGplate pH 3.5–9.5
- IEF electrode strips
- Multiphor II Flatbed Electrophoresis Unit
- MultiTemp III Thermostatic Circulator
- IEF sample applicator strip
- IEF sample application pieces
- EPS 3501 XL or EPS 3501 high-voltage power supply (capable of delivering 3 500 V while limiting both current and power)

3.1.3 Procedure

Sample preparation

1. Dissolve the sample in water to a concentration of 0.5–10 mg/ml for Coomassie Blue staining. Buffers and salts should not be present at a concentration greater than 50 mM. Samples containing insoluble material should be filtered or centrifuged before use.

Instrument and gel preparation

2. Connect the Multiphor II to the thermostatic circulator and set the temperature to 10 °C. Turn on the thermostatic circulator 10 min before starting the analysis.

3. Pipette about 1 ml of kerosene or light paraffin oil onto the cooling plate of the electrophoresis unit.

4. Remove the Ampholine PAGplate from its package and position it in the center of the cooling plate, allowing the kerosene or oil to spread evenly underneath the gel. Make sure no bubbles are trapped beneath the gel.

The gel can be used in one piece or, depending on the number of samples, cut into portions with scissors. If this is done, current and power limits should be reduced accordingly (e.g. if only half a gel is to be run, current and power limits should be set at 25 mA and 15 W, respectively, rather than 50 mA and 30 W). Unused portions of gel can be wrapped in plastic or placed in sealed plastic bags and stored at 4 °C until use.

5. Use scissors to cut off the ends of the electrode strips that protrude beyond the ends of the gel.

6. Soak one IEF electrode strip in IEF anode solution using approximately 3 ml of solution. Remove excess solution with blotting paper (Fig 3.4).

7. Repeat step 6 with a second IEF electrode strip using IEF cathode solution.

8. Apply the electrode strips over the long edges of the gel. The electrode strip soaked with the anodic solution should be toward the anodic (+) side of the cooling plate (Fig 3.5).



Fig 3.4. Soak the electrode strip in analyte or catholyte.



Fig 3.5. Applying an electrode strip near the anode.

Pre-run the gel (optional)

9. Place the electrode holder and align the electrodes over the center of the electrode strips. Lower the electrode holder so that the electrodes rest on the electrode strips. Connect the two electrodes to the base unit and place the lid on the unit.

10. Connect the leads to the power supply. Set the power supply to 1 500 V, limiting the current at 50 mA and the power at 30 W. Run the gel for 15 min.

The voltage should start out between 300–600 V and rise steadily toward 1 500 V during the pre-run step. Pre-running the gel is optional, but can result in a higher-quality separation.

Apply the sample and run the gel

11. Turn off the power supply and disconnect the leads. Take the lid off the unit and remove the electrode holder.

12. Lay the IEF applicator strip across the gel toward either the anodic or cathodic edge. Check that the contact between the gel and the applicator strip is uniform.

The optimal position for sample application varies with sample type and must be determined empirically. This is best done using sample application pieces, which are 5 × 10 mm pads of absorbent material that can be placed in multiple positions on a single gel (Fig 3.6a).

13. Pipette the samples or standards into the wells in the applicator strip or onto the sample application pieces. Use 5–20 µl sample volumes (Fig 3.6b).

14. Place the electrode holder on the Multiphor base and align the electrodes over the center of the electrode strips (Fig 3.7). Lower the electrode holder so that the electrodes rest on the electrode strips. Connect the two electrodes to the base unit and place the lid on the unit.

15. Connect the leads to the power supply. Set the power supply to 1 500 V, limiting the current at 50 mA and the power at 30 W. Run the gel for 1.5 h.

Note: Run conditions and buffers will vary depending on pH range of the Ampholine PAGplate used. Please consult the instruction manual for specific details.

16. Turn off the power supply and disconnect the leads. Take the lid off the unit and remove the electrode holder. Lift the gel off the cooling plate and place in a staining tray and proceed with Coomassie Blue or silver staining as outlined in Chapter 4.



Fig 3.6a. Placing sample application pieces across the gel.



Fig 3.6b. Pipetting samples into the applicator strip wells.



Fig 3.7. Positioning the electrode holder over the electrode strip.

3.2 Denaturing isoelectric focusing

In some cases it is advantageous to perform IEF in the presence of 8 M urea. This denaturant renders some proteins more soluble under IEF conditions, allowing the analysis of samples that cannot be separated under native conditions.

The following protocol separates proteins under denaturing conditions in a range from pH 3 to pH 10. A dried polyacrylamide gel (CleanGel IEF) is rehydrated with the IEF solution before electrophoresis.

3.2.1 Solutions

Denaturing IEF rehydration solution	Final concentration	Amount
<i>(8 M urea, 7.4% v/v Pharmalyte™ carrier ampholyte pH 3–10, 10.5 ml)</i>		
Urea (FW 60.06)	8 M	5.04 g
Pharmalyte 3–10 carrier ampholyte mixture	7.4% (v/v)	780 µl
ddH ₂ O		to 10.5 ml

If desired, a reducing agent (60 mM dithiothreitol [DTT]) and/or a detergent (0.5% (w/v) Triton X-100 or CHAPS) may be added as well.

3.2.2 Materials and equipment

- Denaturing IEF rehydration solution, pH 3–10
- CleanGel IEF (dried polyacrylamide gel on plastic backing)
- Filter paper
- Gel Pool™ rehydration tray
- Rotary laboratory shaker
- Multiphor II Flatbed Electrophoresis Unit
- MultiTemp III Thermostatic Circulator
- IEF sample applicator strip
- IEF sample application pieces
- EPS 3501 XL high-voltage power supply

3.2.3 Procedure

Gel rehydration

1. Open the gel package and remove the dry gel.

The dry gel can be used in one piece or, depending on the number of samples, cut into portions with scissors. Unused portions of gel can be wrapped in plastic or placed in sealed plastic bags and stored at -20 °C until use.

2. Select the appropriate-sized chamber of the rehydration tray. Clean the rehydration tray with distilled or deionized water and dry with tissue paper. Pipette the rehydration solution into the chamber. For a full-size gel, use 10.4 ml. For portions of the gel, reduce the volume accordingly (e.g. use 5.2 ml for half a gel).

The rehydration solution should include the components desired for the separation: urea, carrier ampholytes, plus any detergents or reductants.

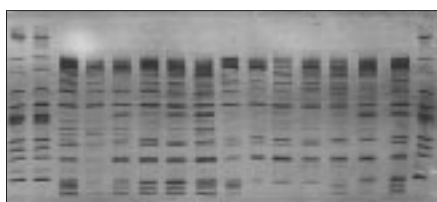

Fig 3.8. Example of isoelectric focusing using CleanGel IEF.

3. Set the edge of the gel film, with the gel surface facing down, into the rehydration solution and slowly lower the rest of the gel into the solution. Lift the film at the edges with forceps and slowly lower it down again to ensure an even distribution of the liquid and to remove air bubbles. Place the rehydration tray on a rotary laboratory shaker and shake gently. Allow the gel to rehydrate 4 h to overnight.

When including urea, overnight rehydration ensures complete absorption.

Sample preparation

4. Dissolve or dilute the sample into denaturing IEF rehydration solution (the composition of the sample solution should be as similar as possible to the composition of the rehydration solution). If the gel is to be stained with Coomassie Blue, the protein concentration in the sample should be 1–3 mg/ml. Buffers and salts should not be present at a concentration greater than 50 mM. Samples containing insoluble material should be filtered or centrifuged before use.

Instrument and gel preparation

5. Connect the Multiphor II Electrophoresis Unit to the thermostatic circulator and set the temperature to 15 °C. Turn on the thermostatic circulator 10 min before starting the analysis.

6. Pipette about 1 ml of kerosene or oil onto the cooling plate of the electrophoresis unit.

7. Remove the gel from the rehydration tray and carefully dry the surface by gliding the edge of a sheet of filter paper across the surface.

8. Position the gel in the center of the cooling plate, allowing the kerosene or oil to spread evenly underneath the gel. Make sure no bubbles are trapped beneath the gel (Fig 2.23).

Pre-run the gel

9. Place the electrode holder with the IEF electrodes on the electrophoresis unit and align the electrodes so that they rest on the outer edges of the gel. Electrode wicks are not necessary. Lower the electrode holder into place. Connect the two electrodes to the base unit and place the lid on the unit.

10. Connect the leads to the power supply. Follow the recommended settings given in Table 3.2. Pre-run the gel for 20 min.

Apply the sample and run the gel

11. Turn off the power supply and disconnect the leads. Take the lid off the unit and remove the electrode holder.

12. Lay the IEF applicator strip across the gel toward either the anodic or cathodic edge. Check that the contact between the gel and the applicator strip is uniform.



Fig 3.9a. Placing sample application pieces across the gel.



Fig 3.9b. Pipetting samples into applicator strip wells.



Fig 3.9c. Position the electrode holder over the electrode strip.

The optimal position for sample application varies with sample type and must be determined empirically. This is best done using sample application pieces, which are 5 × 10 mm pads of absorbent material that can be placed in multiple positions on a single gel (Fig 3.9a).

13. Pipette the samples or standards into the wells in the applicator strip or onto the sample application pieces. Use 5–20 µl sample volumes (Fig 3.9b).

14. Place the electrode holder on the Multiphor base and align the electrodes so that they rest on the outer edges of the gel. Lower the electrode holder into place. Connect the two electrodes to the base unit and place the lid on the unit (Fig 3.9c).

15. Connect the leads to the power supply. Run the gel according to the recommended settings given in Table 3.2.

Table 3.2. Running conditions for denaturing IEF

Step	Voltage (V)	Current (mA)*	Power (W)*	Time (min)
Pre-run	700	12	8	20
Sample entrance	500	8	8	20
Isoelectric focusing	2 000	14	14	90
Band sharpening	2 500	14	18	10

*If only a portion of the gel is run, current and power limits should be reduced accordingly for the run (e.g. if only half a gel is to be run, current and power limits should be set at 7 mA and 7 W, respectively, rather than 14 mA and 14 W).

16. When electrophoresis is complete, turn off the power supply and disconnect the leads. Take the lid off the unit and remove the electrode holder. Lift gel into a staining tray and proceed with the desired staining protocol outlined in Chapter 4.

3.3 Isoelectric focusing using immobilized pH gradient (IPG) gels

Figure 3.10 illustrates the separation of bovine erythrocyte carbonic anhydrase using an Immobiline DryPlate IEF, pH 4.0–7.0.

3.3.1 Materials and equipment

- DryPlate reswelling cassette and clamps
- Immobiline DryPlate, pH 4.0–7.0 (dry, precast polyacrylamide gel containing preformed, immobilized pH gradient)
- Kerosene or light paraffin oil
- 10 ml pipette
- Repel-Silane ES
- Multiphor II Flatbed Electrophoresis Unit
- MultiTemp III Thermostatic Circulator
- IEF sample applicator strip
- IEF sample application pieces
- EPS 3501 XL high-voltage power supply
- Roller

3.3.2 Procedure

Assemble the reswelling cassette

1. Wash the glass plates with detergent, rinse with distilled or deionized water, and dry with a paper towel.
2. Swab the gasketed glass plate with Repel-Silane ES to prevent the gel from sticking to the plate. Rinse off excess with water and air dry.
3. Remove the DryPlate from the freezer. Wearing gloves, remove the gel from the package. Be careful not to damage the gel while removing it from the package: The gel faces the aluminum foil side of the package.

The gel can be used in one piece depending on the number of samples, or cut into portions with scissors. If this is done, current and power limits should be reduced accordingly. Unused portions of gel can be wrapped in plastic or placed in sealed plastic bags and stored at 4 °C.

4. Apply small drops of distilled water on the outer edges and middle of the plain glass plate. Carefully lay the gel onto the glass plate, support film side facing down. Roll the gel flat to remove air bubbles and to ensure good contact with the plate. Blot away any excess water that is squeezed out.

5. Clamp the glass plates together with rubber-edged clamps (Fig 3.11), making sure that the V-indentations and support film are on the inside.

Reswell the gel

6. Fill the cassette with 20 ml of reswelling solution, using a 10 ml pipette.

For water-soluble proteins, distilled water can be used. Alternatively, gels can be rehydrated with additives, such as urea and nonionic detergents. See the DryPlate instructions for further information.

7. Reswell the gel for 1–2 h when using water, 15–18 h when using urea and nonionic detergents.
8. Remove the clamps and disassemble the mold by gently prying the plates apart with a long razor blade.

Sample preparation

9. Dissolve the sample in water to a concentration of 0.5–10 mg/ml for Coomassie Blue staining. Buffers and salts should not be present at a concentration greater than 50 mM. Samples containing insoluble material should be filtered or centrifuged before use.

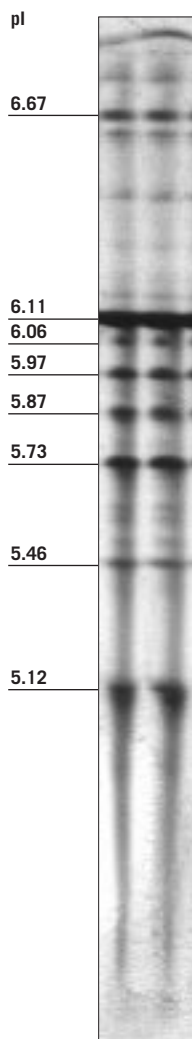

Fig 3.10. IPG analysis of bovine erythrocyte carbonic anhydrase.

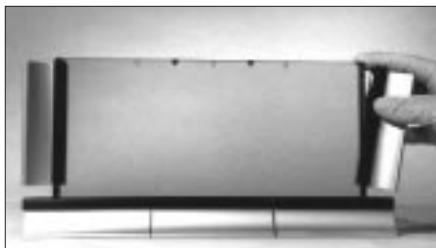

Fig 3.11. Clamp together the glass plates of the reswelling cassette.

Instrument and gel preparation

10. Connect the Multiphor II to the thermostatic circulator and set the temperature to 10 °C (20 °C if using urea concentrations above 4 M). Turn on the thermostatic circulator 10 min before starting the analysis.
11. Pipette about 1 ml of kerosene or oil onto the cooling plate of the electrophoresis unit.
12. Orient the gel so that the notch at the lower-left corner of the film faces the anodic (+) electrode. Position the gel in the center of the cooling plate, allowing the kerosene or oil to spread evenly underneath the gel. Make sure no bubbles are trapped beneath the gel.
13. Use scissors to cut off the ends of the electrode strips that protrude beyond the ends of the gel.
14. Soak IEF electrode strips in water. Remove excess solution with blotting paper.
15. Apply the electrode strips over the long edges of the gel.

Apply the sample and run the gel

16. Lay the IEF applicator strip across the gel toward either the anodic or cathodic edge. Check that contact between the gel and the applicator strip is uniform.

The optimal position for sample application varies with sample type and must be determined empirically. This is best done using sample application pieces, which are 5 × 10 mm pads of absorbent material that can be placed in multiple positions on a single gel (Fig 3.12).

17. Pipette the samples or standards into the wells in the applicator strip or onto the sample application pieces. Use 5–20 µl sample volumes. (Fig 3.13).

18. Place the electrode holder and align the electrodes over the center of the electrode strips. Lower the electrode holder into place. Connect the two electrodes to the base unit and place the lid on the unit.

19. Connect the leads to the power supply. Set the power supply to 3 500 V, limiting the current at 5 mA and the power at 15 W. Run the gel for 2–4 h.

Note: The run times will vary for different gels, depending on the pH range of the gel, and must be determined empirically.

20. Turn off the power supply and disconnect the leads. Take the lid off the unit and remove the electrode holder. Lift the gel off the cooling plate and place in a staining tray and proceed with Coomassie Blue or silver staining as outlined in Chapter 4.



Fig 3.12. Placing sample application pieces across the gel.



Fig 3.13. Pipetting samples into applicator strip wells.

3.4 Troubleshooting

Problem	Possible cause	Remedy
Low or no current	Poor contact between electrodes and electrode strips	Make sure that electrode strips are correctly placed. Low current is normal in IEF; gel currents will drop to 1–5 mA.
Current rises during the run	Electrode strips or electrodes are mixed up	Check polarity; check pH of electrode strips
Condensation	Insufficient cooling	Check coolant flow and temperature
Sparking on gel	Drying out of gel close to electrodes	Incorrect electrode solutions; use recommended solutions
	Excessive power input	Check power supply settings
	Excess moisture	Remove excess moisture by gently drawing a clean sheet of filter paper across gel surface
Wavy bands	Poor electrode contact	Check electrode contact
	Incorrect electrode solutions	Use recommended solutions
	Uneven cooling across gel	Remove all air bubbles between gel backing sheet and cooling platform
	Debris in sample	Centrifuge to remove particulates
	Sample too concentrated	Load less protein
	Excessive salt in sample	Desalt samples
Fuzzy bands	Focusing was not long enough	Increase focusing time
Streaking of the bands	Sample may contain too high a concentration of salts, buffers, or other small charged molecules	Decrease their concentration

3.5 References and bibliography

Guide to Protein Purification. *Methods in Enzymology* Vol. 182 (Deutscher, M. P., ed.), Academic Press, San Diego (1990).

Righetti, P. G. *et al.* Conventional isoelectric focusing in gel slabs, in capillaries, and immobilized pH gradients. In *Gel Electrophoresis of Proteins. A Practical Approach* 3rd ed. (Hames, B. D., ed.). Oxford University Press, New York, pp. 127–187 (1998).

Westermeier, R. *Electrophoresis in Practice* 2nd ed. VCH, Weinheim, Germany (1997).

Chapter 4

Analysis of gels

Once electrophoresis is complete, the gel must be analyzed to obtain information on the position and quantity of each protein. Because most proteins are not directly visible, the gel must be processed to determine the location and amount of the separated proteins. The most common analytical procedure is staining. Proteins are usually stained with silver or Coomassie Blue. Once the gel is stained, it can be photographed or dried on a backing for a record of the position and intensity of each band and then analyzed.

The following sections outline basic protocols for Coomassie Blue staining, silver staining, gel drying and storage, gel documentation, and estimation of molecular weight.

4.1 Staining gels with Coomassie Brilliant Blue

Detection limit: 0.1–0.5 μg of protein

Coomassie Blue staining is based on the binding of the dye Coomassie Brilliant Blue R250, which binds nonspecifically to virtually all proteins. Although Coomassie Blue staining is less sensitive than silver staining, it is widely used due to its convenience. The gel is soaked in a solution of the dye. Any dye that is not bound to protein diffuses out of the gel during the destain steps. Coomassie Blue binds to proteins approximately stoichiometrically, so this staining method is preferable when relative amounts of protein need to be determined by densitometry. For most SDS and native gels, separated proteins can be simultaneously fixed and stained in the same solution. The gel is then destained to remove the background prior to drying and documenting. The proteins are detected as blue bands on a clear background. When staining IEF gels with Coomassie Blue, the gel is first fixed in a trichloroacetic acid solution. This leaches out the carrier ampholytes, which would otherwise produce background staining. When staining small peptides ($M_r < 10\,000$), the gel is first fixed in a solution containing glutaraldehyde to cross-link the peptides and prevent them from diffusing out of the gel during subsequent staining steps.

Danger! TCA is a strong acid and very corrosive. Use proper safety equipment when handling and use TCA-resistant containers for staining.

4.1.1 Coomassie Blue staining stock solutions

Always wear gloves and use double-distilled, deionized, or other high-quality water.

Trichloroacetic acid fixing solution (for IEF gels)	Final concentration	Amount
<i>(20% (w/v) trichloroacetic acid, 500 ml)</i>		
Trichloroacetic acid (FW 163.4)	20%	100 g
ddH ₂ O		to 500 ml

Store up to 1 mo at room temperature.

Glutaraldehyde fixing solution (for visualizing proteins with M_r < 10 000)		
<i>(0.2% (v/v) glutaraldehyde, 30% (v/v) ethanol, 0.2 M sodium acetate, 500 ml)</i>		
25% glutaraldehyde	0.2%	4 ml
Ethanol	30%	150 ml
Sodium acetate trihydrate (FW 136.1)	0.2 M	13.61 g
ddH ₂ O		to 500 ml

Use immediately.

Coomassie Blue staining solution		
<i>(0.025% Coomassie Brilliant Blue R250, 40% (v/v) methanol, 7% (v/v) acetic acid, 2 l)</i>		
Coomassie Brilliant Blue R250	0.025%	0.5 g
Methanol	40%	800 ml
Stir until dissolved. Filter. Then add:		
Acetic acid	7%	140 ml
ddH ₂ O		to 2 l

Store at room temperature for up to 6 mo.

Destain solution I		
<i>(40% (v/v) methanol, 7% (v/v) acetic acid, 1 l)</i>		
Methanol	40%	400 ml
Acetic acid	7%	70 ml
ddH ₂ O		to 1 l

Store at room temperature.

Destain solution II		
<i>(7% (v/v) acetic acid, 5% (v/v) methanol, 10 l)</i>		
Acetic acid	7%	700 ml
Methanol	5%	500 ml
ddH ₂ O		to 10 l

Store at room temperature.

4.1.2 Materials and equipment

- Trichloroacetic acid fixing solution (required only for IEF gels)
- Glutaraldehyde fixing solution (required only for Tris-tricine gels)
- Coomassie Blue staining solution
- Destain solution I
- Destain solution II
- Covered tray
- Laboratory shaker or rocker
- Hoefer Processor Plus (optional—see section 4.1.4)

4.1.3 Standard Coomassie Blue protocol

Perform staining at room temperature. Covered plastic trays work well and minimize exposure to methanol and acetic acid vapors. When covers are not used, these procedures should be done in a fume hood.

When staining conventional SDS or native gels, skip ahead to step 2. A fixing step is not required for these gels.

1. *IEF gels*: Submerge the gel in trichloroacetic acid fixing solution. Shake slowly on a laboratory shaker or rocker for 30–60 min. Replace the trichloroacetic acid fixing solution with destain solution I and shake slowly for 3 min.

Note: Do not leave a gel in trichloroacetic acid fixing solution for more than 60 min.

Gels used for separating proteins and peptides $M_r < 10\,000$: Submerge the gel in glutaraldehyde fixing solution. Shake slowly on a laboratory shaker or rocker for 30–60 min.

2. *For conventional SDS and native gels, start with this step*: Submerge the gel in enough Coomassie Blue staining solution that the gel floats freely in the tray. Shake slowly on a laboratory shaker or rocker for 4 h to overnight.

The amount of time required to stain the gel depends in part on the thickness of the gel. A 0.75-mm-thick gel will stain faster than a 1.5 mm gel and may be completely stained in an hour.

Note: If using the Hoefer Processor Plus for automated staining, see section 4.1.4.

3. Replace the staining solution with destain solution I. Shake slowly 30 min. This removes the bulk of the excess stain.

4. Remove destain solution I and replace with destain solution II. Change the destain solution II periodically until the gel background is clear. Alternatively, the addition of a paper laboratory wipe to one corner of the staining tray will help remove Coomassie Blue from the gel without changing



Fig 4.1. Processor Plus with large gel staining tray.

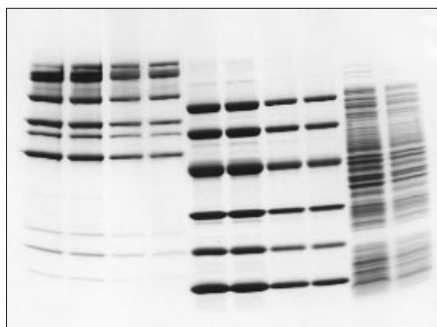

Fig 4.2. 4–20% gradient gel stained with Coomassie Blue.

the destain solution, minimizing the waste volume generated. Replace the wipes when they are saturated with dye. Use caution, however, because excessive destaining will lead to loss of band intensity.

5. Store the gel in destain solution II. To minimize cracking, add 1% glycerol to the last destaining before drying the gel.

4.1.4 Automated Coomassie Blue staining

Use the Hoefer Processor Plus to automate the gel staining procedure, performing all staining and destaining steps unattended. Although Coomassie staining is a simple procedure, automation offers the benefit of allowing the user to do other work without interruption and return to a stained (and destained) gel, often the next morning. To use, set up the Processor Plus with bottles containing the staining reagents and choose a preprogrammed protocol for Coomassie staining. After starting, the Processor Plus delivers the solutions to the tray, rocks the gels gently, empties the tray, and continues through the complete procedure. See Table 4.0 for a list of preprogrammed protocols for the Processor Plus.

For more-detailed information, see the technical brochure “Automated Staining of Polyacrylamide Gels with the Hoefer Processor Plus” (80-6343-34).

4.2 Silver staining

Detection limit: 1–5 μg of protein

Silver staining is the most sensitive method for permanent visible staining of proteins in polyacrylamide gels. This sensitivity, however, comes at the expense of high susceptibility to interference from a number of factors. Precise timing, high-quality reagents, and cleanliness are essential for reproducible, high-quality results. In silver staining, the gel is impregnated with soluble silver ions and developed by treatment with formaldehyde, which reduces silver ions to form an insoluble brown precipitate of metallic silver. This reduction is promoted by protein. There are many variations of the silver staining process. The method described here is based to the method of Heukeshoven and Dernick (1985) and has been selected for overall convenience, sensitivity, reproducibility, and speed.

Note: This silver staining method is available as the PlusOne Protein Silver Staining Kit (17-1150-01). The use of a silver staining kit provides the convenience of pre-measured reagents and more consistent quality.

Wear gloves and use only glass-distilled water. Glass staining trays are particularly useful because they are easy to clean. All steps can be done at room temperature.

4.2.1 Silver staining stock solutions

Silver stain fixing solution	Final concentration	Amount
<i>(40% (v/v) ethanol, 10% (v/v) acetic acid, 1 l)</i>		
Ethanol, absolute	40%	400 ml
Acetic acid, glacial	10%	100 ml
Distilled or deionized water		to 1 l

Sensitizing solution

(30% (v/v) ethanol, 6.8% (w/v) sodium acetate, 0.2% (w/v) sodium thiosulphate, 0.125% (v/v) glutaraldehyde, 1 l)

Ethanol, absolute	30%	300 ml
Sodium acetate, anhydrous (FW 82.03)	6.8%	68 g
Sodium thiosulphate, pentahydrate (FW 248.18)	0.2%	2 g
Distilled or deionized water		to 1 l

Store stock solution without glutaraldehyde at room temperature for up to 2 mo.
Within 1 h of use, add:

25% glutaraldehyde	0.125%	0.5 ml per 100 ml of solution used
--------------------	--------	------------------------------------

Silver solution

(0.25% (w/v) silver nitrate, 0.015% (v/v) formaldehyde, 1 l)

Silver nitrate (FW 169.87)	0.25%	2.5 g
Distilled or deionized water		to 1 l

Store stock solution without formaldehyde in a dark bottle at room temperature for up to 2 mo.
Within 1 h of use, add:

37% formaldehyde	0.015%	40 µl per 100 ml of solution used
------------------	--------	-----------------------------------

Developing solution

(2.5% (w/v) sodium carbonate, 0.0074% (v/v) formaldehyde, 1 l)

Sodium carbonate, anhydrous (FW 105.99)	2.5%	25 g
Distilled or deionized water		to a total volume of 1 l

Store stock solution without formaldehyde at room temperature for up to 2 mo.
Within 1 h of use, add:

37% formaldehyde	0.0074%	20 µl per 100 ml of solution used
------------------	---------	-----------------------------------

Stop solution

(1.5% (w/v) Na₂EDTA, 1 l)

Na ₂ EDTA (ethylenediaminetetraacetic acid, disodium salt) (FW 372.24)	1.5%	15 g
Distilled or deionized water		to 1 l

Store at room temperature for up to 6 mo.

Preserving solution

(30% (v/v) ethanol, 4% (v/v) glycerol, 1 l)

Ethanol, absolute	30%	300 ml
Glycerol	4%	40 ml
Distilled or deionized water		to 1 l

Store at room temperature for up to 6 mo.

Table 4.0 Processor Plus capabilities

The Processor Plus has a total of nine preprogrammed protocols including:

Protein Coomassie staining—SDS and native
Protein Coomassie staining—IEF
Protein silver staining—SDS and native
Protein silver staining—IEF
DNA silver staining

For more information on automating silver staining, see the technical brochure “Automated Staining of Polyacrylamide Gels with the Hoefer Processor Plus” (80-6343-34).

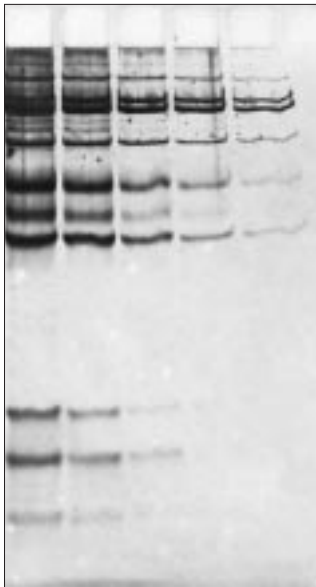

Fig 4.3. Example of a silver stained ExcelGel 12.5%.

4.2.2 Materials and equipment

- Silver staining fixing solution
- Sensitizing solution
- Silver solution
- Developing solution
- Stopping solution
- Preserving solution
- Covered tray
- Laboratory shaker or rocker
- Hoefer Processor Plus (optional)

4.2.3 Silver staining protocol

Silver staining is a complex, multistep process, and many variables can influence the results. High-purity reagents and precise timing are essential for reproducible, high-quality results. Impurities in the gel and/or the water used for preparing the staining reagents can cause poor staining results.

Automation of the silver staining process with the Hoefer Processor Plus and the use of PlusOne™ Silver Staining Kits eliminate most of the variables associated with silver staining. Precise control of timing and the use of standard, prepackaged reagents provide exceptional reproducibility and free the user from the necessity to be present throughout this onerous procedure. The following protocol is easily performed with the Processor Plus or can be carried out manually using trays on a shaker.

Process the gel(s) according to Table 4.1. Use 250 ml of each solution per gel for standard (14 × 16 cm) gels. Use 100 ml of each solution per gel for mini-format (8 × 10 cm) gels. The timing of some of the steps differs according to the thickness of the gel as indicated in the table. Shake slowly on a laboratory shaker or rocker.

Table 4.1. Silver staining protocol

Solution	Time for 1-mm-thick gel	Time for 1.5-mm-thick gel
Silver staining fixing solution*	30 min	30 min
Sensitizing solution	30 min	30 min
Distilled or deionized water	3 × 5 min	3 × 10 min
Silver solution	20 min	30 min
Distilled or deionized water	2 × 1 min	2 × 1 min
Developing solution	3–5 min [†]	5–10 min [†]
Stopping solution	10 min	10 min
Distilled or deionized water	3 × 5 min	3 × 5 min
Preserving solution [‡]	30 min	30 min

*The gel(s) can be left in this solution until a convenient time for completing the procedure (up to 1 wk).

[†]Monitor development and change the solution when protein bands are visible and the background is just starting to darken.

[‡]Gels can be stored in this solution. The glycerol in the preserving solution will prevent the gels from cracking when dried.

Note: This protocol gives the best results when applied to standard SDS and native gels. High levels of background staining can be expected on IEF gels unless extra steps are taken to remove interfering carrier ampholytes before staining. When staining IEF gels, the silver staining protocol outlined above should be preceded by an additional 30-min fixing step in trichloroacetic acid fixing solution. For solution recipe see Coomassie Blue staining solutions in section 4.1.1. Additional washing between the sensitizing step and the silver step may also be necessary.

4.3 Gel drying and storage

4.3.1 Storage

Gels can be stored either wet or dried. To store wet gels, simply place the wet gel onto a sheet of plastic wrap and fold the wrap over the gel. This permits handling the gel without the risk of breakage. Insert the wrapped gel into a plastic bag and seal at 4 °C up to 1 yr.

4.3.2 Drying gels by vacuum

For vacuum drying on a paper support, use Hoefer GD 2000 Vacuum Gel Dryer System (Fig 4.4) or equivalent. Place the destained gel onto a sheet of filter paper of the same size. This is placed on a larger sheet of filter paper covering the metal screen on the dryer platen. Cover the top of the gel with plastic wrap and then lower the silicone dryer cover flap. Apply vacuum to seal the flap, then turn on the heater and timer.

During vacuum drying, the gel will feel cold relative to the surrounding platen if it is not completely dry. When the temperature of the gel is the same as that of the platen, the gel is dry and the vacuum and dryer can be turned off.

Gels may crack if the vacuum is released before the gel is completely dry, if the vacuum is poor due to a leak in the system, or if the cold trap is full. Some pumps, such as the Hoefer diaphragm pump, do not require a cold trap and can be attached directly to the dryer for simpler, more reliable operation. The percentage of acrylamide and gel thickness also influence gel cracking. In general, gels ≤ 0.75 mm thick dry without cracking regardless of the acrylamide percentage. With gels thicker than 0.75 mm, the following guidelines are recommended: Up to 12.5% acrylamide, dry the gel without any special treatments. For $>12.5\%$, add 1–2% glycerol to the final destain or storage solution prior to drying. For thick (>1.0 mm) or for high-percentage ($>12.5\%$) gels, place gels back into destain I containing 2% glycerol for 30–60 min before drying to dehydrate and shrink the gel. This reduces cracking by minimizing the shrinkage that normally occurs as gels dry.

4.3.3 Air drying using Easy Breeze™

To air dry, place the gel between two sheets of porous cellophane and lock into the drying frame. Insert the frame into the air dryer and turn on fan and heater. Moisture evaporates through the cellophane, leaving a flat, easy-to-store gel with a clear background. Gels dry in less than 2 h. (Fig 4.5).



Fig 4.4. Hoefer GD 2000 Vacuum Gel Dryer System.



Fig 4.5 Hoefer SE 1200 Easy Breeze Air Gel Dryer.

4.4 Documentation

Although gels are easy to store, it is more convenient to store a photograph, printout, or scan of a gel. Numerous methods and technology exist for capturing images for subsequent analysis or storage.

4.4.1 Photography

Photography using instant film is convenient and simple. The initial cost of the camera is relatively low; however, pictures cannot be further manipulated. Film is available to make both positive prints and image negatives.

4.4.2 Densitometer

Densitometry generates a peak diagram (densitogram) from which the area under each peak can be determined, representing the intensity of bands in the gel.

4.4.3 Scanners and digital cameras

In recent years many laboratories have acquired digital documentation systems that capture and store images of gels. Instruments include digital CCD cameras, such as the ImageMaster™ VDS photo documentation system, or scanners (such as the ImageMaster Desktop Scanner). The advantages of digital image acquisition include speed and the ease of direct quantitative analysis of the image with software that automatically calculates molecular weight and band intensity. Furthermore, the image can be annotated for recordkeeping and publication.

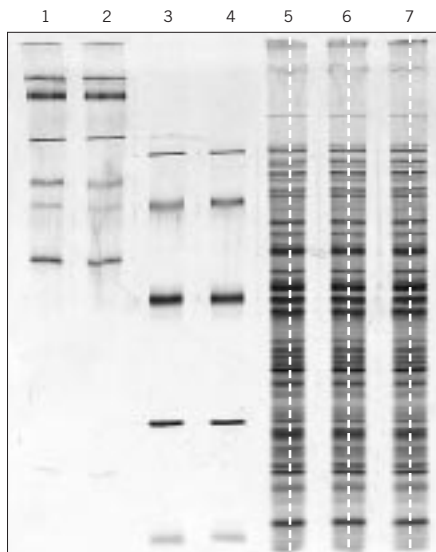

Fig 4.6. Digital image of silver stained gel.

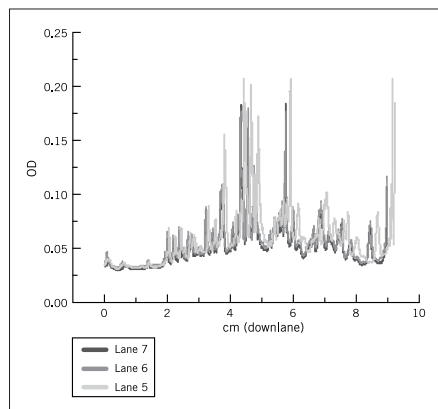

Fig 4.7. Density profiles of lanes 5, 6, 7 from image in Figure 4.6.

4.5 Estimation of protein molecular weights by SDS gel electrophoresis

Estimating the size or molecular weight of a protein is relatively straightforward with SDS gels. The general procedure is to separate a set of standards (proteins with known molecular weights) in parallel with the unknown or sample protein. The standards are used to generate a curve correlating molecular weight and migration in the gel, from which the molecular weight of the unknown sample can be determined. The gel concentration should be chosen so that the standards produce a linear curve in the region of the unknown.

The following is the basic molecular weight calculation procedure.

4.5.1 Materials and equipment

- Processed SDS gel with standards (either gradient or single-concentration gel)
- Calculator capable of two-variable statistics, or a computer with spreadsheet or graphing software
- Ruler with 0.1 cm markings (included, Fig 4.8)
- Rf calculator overlay (optional—included, Fig 4.8)
- Log-Linear graph paper

4.5.2 Procedure

1. Determine the migration distance into the gel or relative mobility of the standard and unknown proteins using the overlay template provided in Figure 4.8. Transfer the data to Table 4.2 to complete the calculations.

Relative mobility is defined as:

$$R_f = \frac{\text{distance migrated by protein}}{\text{distance migrated by marker}}$$

Usually, the dye front serves as the relative mobility marker. Alternatively, a low-molecular-weight standard protein can serve as the relative mobility marker. Frequently, with gradient gels the dye front is diffuse or will run off the bottom of the gel, and selecting an internal protein marker is useful. Last, one of the simplest approaches to estimating molecular weights simply uses migration distance into the gel without converting to a relative mobility. The use of an internal marker (dye or protein) corrects for lane-to-lane differences in mobility.

2. Plot the log protein size (y-axis) versus mobility (x-axis).

With gradient gels, an alternative “x-axis” is frequently used. Plotting the log molecular weight (y) versus log%T (x), produces very good linearity (Hames, 1998). Simply using migration distance or relative mobility for the x-axis, however, generally produces adequately straight calibration lines and is much simpler to determine.

Table 4.2. Protein standards with approximate molecular weights

Standard	Size	Log size	Migration distance	Relative mobility
Phosphorylase b	94 000	4.9731		
Albumin	67 000	4.8261		
Ovalbumin	43 000	4.6335		
Carbonic anhydrase	30 000	4.4771		
Trypsin inhibitor	20 100	4.3032		
α-lactalbumin	14 400	4.1584		
Unknown #1				
Unknown #2				



cm rule and relative mobility calculator

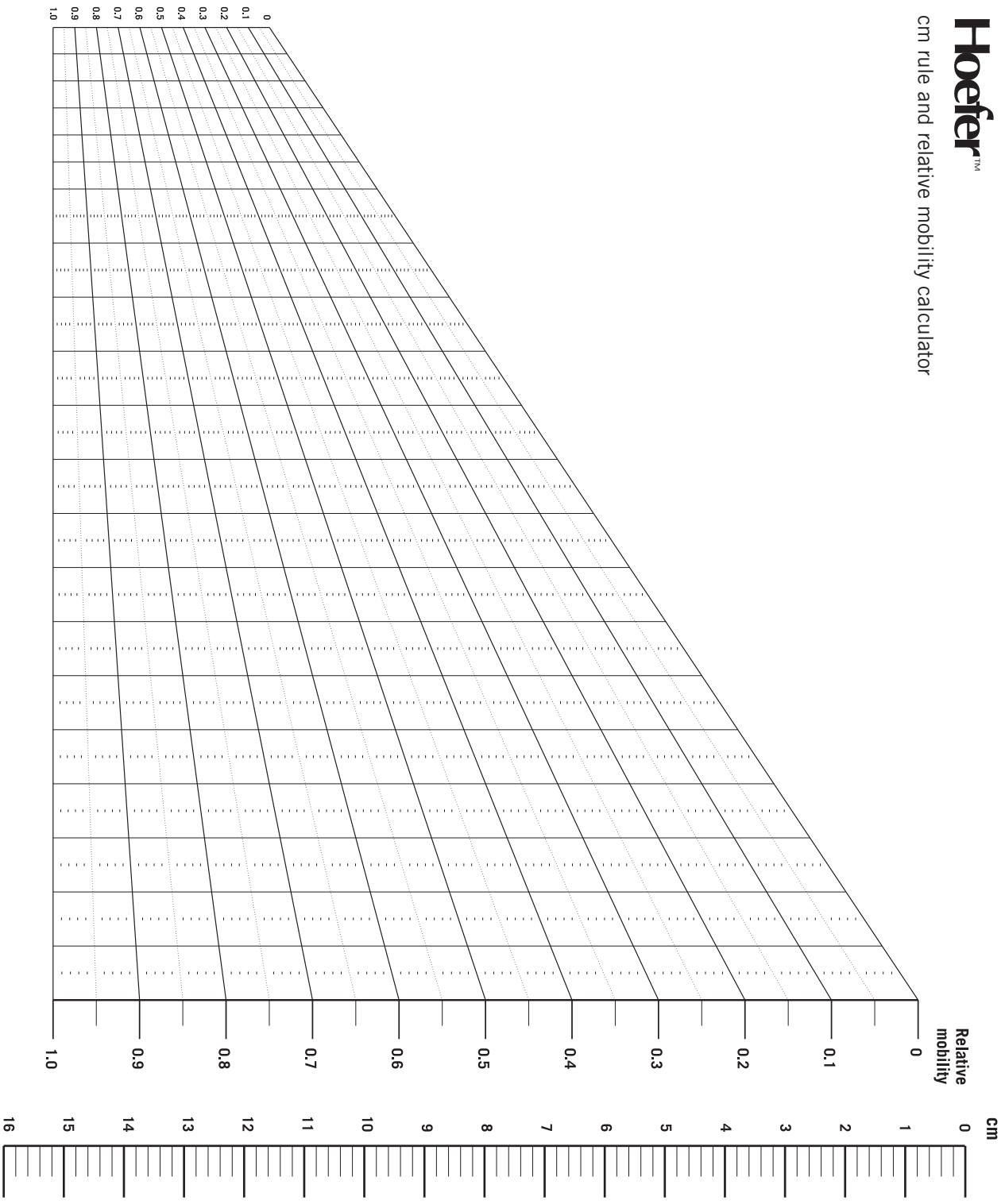

Fig 4.8.

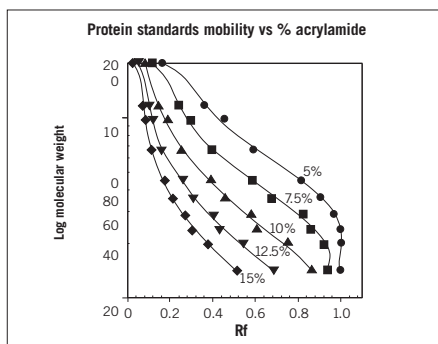

Fig 4.9. Calibration curves of protein standards at five concentrations of acrylamide. Data taken from Smejkal and Gallagher (1994) with the end of the gel used as the relative mobility marker.

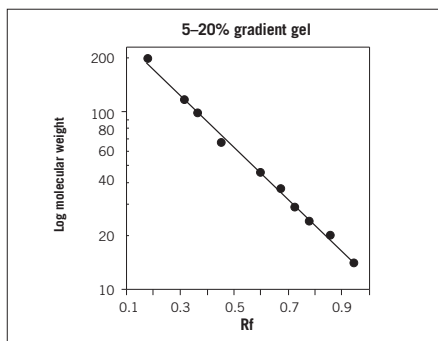

Fig 4.10. Calibration curves of protein standards taken from the gel in Figure 4.11 below. Rf marker was the end of the gel.

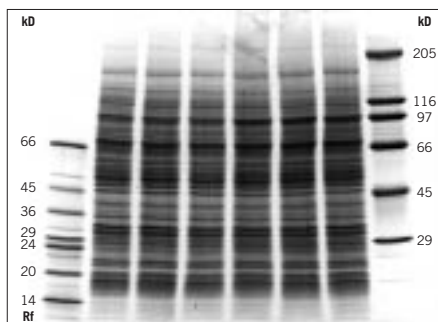

Fig 4.11. 5–20% acrylamide gradient gel. 0.75-mm-thick SDS gel was separated overnight at 4 mA and stained with Coomassie Blue. Outside lanes contain protein standards with their sizes listed in kilodaltons.

Figure 4.9 illustrates the mobility of standard proteins at several polyacrylamide gel concentrations. Note that the curves are linear only over a limited range of molecular weights. In contrast, gradient gels display linear mobility over a wide range of protein sizes on a single gel (Figs 4.10 and 4.11).

3. Use a calculator or a computer program to perform linear regression of the data.
4. Once the regression line has been calculated, use the equation of the line to estimate the size of the unknown protein.

The purpose of plotting the data and performing the regression is to generate a linear curve through the standards so that the size of the unknown can be estimated. Thus, choose a region of the plotted data that is reasonably linear for performing the regression. Use Figure 4.9 to estimate the concentration of acrylamide to use to get a linear standard curve in the region of the unknown. Alternatively, use gradient gels for wide-range linearity.

The general equation of a straight line is:

$$y = mx + b$$

where m is the slope and b is the y -intercept. In this case, the equation becomes:

$$\text{log molecular weight} = (\text{slope})(\text{mobility}) + \text{y-intercept}$$

Most scientific calculators will generate the required parameters automatically as the log molecular weight (y data) and the mobility (x data) are entered. Determining the size of an unknown becomes straightforward simply by placing the unknown or sample protein mobility (x) into the equation and calculating y (log molecular weight).

4.6 Troubleshooting

Problem	Possible cause	Remedy
Coomassie stain		
Bands poorly stained	Insufficient staining time	Increase staining time
Blue background	Gel insufficiently destained	Increase destaining time or changes of destain
Silver stain		
Bands develop poorly or not at all	Staining solutions not prepared or timed correctly	Prepare solutions again
	Ambient temperature below 20 °C	Lengthen development time
Background is excessively dark	Water impure	Use distilled or deionized water; use water with a resistivity of $\geq 5 \text{ M}\Omega$
	Interfering substances not completely washed out	Increase fixing step
	Washing steps too short	Lengthen washing step after sensitization
	Development too long	Shorten development time
	Ambient temperature above 27 °C	Shorten development time
Bands lighter than background	Overloading	Reduce amount of protein loaded on gel
Smearing or blackening in lanes in which protein is loaded	Overloading	Reduce amount of protein loaded on gel
Dark streaks and spots	Dirt and fingerprints	Thoroughly clean gel equipment and glass plates; use gloves when handling gels

4.7 References and bibliography

Hames, B. D., ed., *Gel Electrophoresis of Proteins: A Practical Approach* 3rd ed., Oxford University Press, New York (1998).

Heukeshoven, J., and Dernick, R., *Electrophoresis* **6**, 103–112 (1985).

Merril, C. R., and Washart, K. M., in *Gel Electrophoresis of Proteins: A Practical Approach* 3rd ed. (Hanes, B. D., ed.), Oxford University Press, New York. pp. 53–91 (1998).

Merril, C. R., *et al.*, *Methods Enzymol.* **104**, 441–447 (1984).

Morrissey, J. H., *Anal. Biochem.* **117**, 307–310 (1981).

Oakley, B. R., *et al.*, *Anal. Biochem.* **105**, 361–363 (1980).

Sasse, J., and Gallagher, S. R., in *Current Protocols in Molecular Biology* Unit 10.6 (Ausubel, F. A., *et al.*, eds.), Wiley-Interscience, New York (1991).

Switzer, R. C., *et al.*, *Anal. Biochem.* **98**, 231–237 (1979).

Wilson, C. M., *Methods Enzymol.* **91**, 236–247 (1983).

Glossary

ammonium persulphate The initiator of acrylamide polymerization. Used with TEMED to prepare polyacrylamide gels.

ampholyte The general term for amphoteric compounds (i.e. compounds having both acidic and basic groups, H⁺ donor and acceptors, respectively) used in isoelectric focusing. Ampholytes form a pH gradient by migrating during electrophoresis to their isoelectric point in the gel. The exact isoelectric point depends on the number and proportion of acidic and basic groups and their pK's. These titratable groups define the pH at the isoelectric point by their buffering capacity. A variety of pH ranges are available commercially.

anode The positive (+) electrode. Negatively charged proteins (anions) move toward the anode. The anode is connected to the power supply with the red high-voltage lead.

anolyte The electrode solution used in the positive (+) or anodic buffer chamber in systems where two separate electrode buffers are used, such as isoelectric focusing. Typically, phosphoric or acetic acid is used.

antigen A compound that, when injected into an animal, causes the production of antibodies.

cathode The negative (–) electrode. Positively charged proteins (cations) move toward the cathode. The cathode is connected to the power supply with the black high-voltage lead.

catholyte The electrode solution used in the negative (–) or cathodic buffer chamber in systems where two separate electrode buffers are used, such as isoelectric focusing. Typically sodium hydroxide or histidine is used.

%C – The percentage of cross-linker in the polyacrylamide solution:

$$\%C = \frac{\text{g(bisacrylamide)}}{\text{g(acrylamide + bisacrylamide)}} \times 100$$

The amount of cross-linker (bisacrylamide) varies depending on the application. The increased cross-linking gives a stronger gel, an important consideration for low-percentage acrylamide gels.

CHAPS [3-(3-cholamidopropyl)[dimethylammonio]-1-propanesulphonate] A zwitterionic detergent with the ability to disrupt nonspecific protein interactions and preserve the native form of proteins. Used for protein solubilization during sample preparation for IEF and 2-D electrophoresis.

Coomassie Brilliant Blue R250, R350, and G250 Protein stains used to visualize proteins after electrophoresis.

discontinuous gel electrophoresis Gel electrophoresis with different stacking and separating buffers to resolve macromolecules such as proteins. Discontinuous electrophoresis provides superior resolution compared with continuous (single-buffer) systems.

electrophoresis The movement of a charged molecule under the influence of an electric field.

isoelectric focusing (IEF) Separation of proteins based on their isoelectric point.

molecular weight and molecular mass These two expressions are not equivalent (Instructions to Authors, *Journal of Biological Chemistry*), although they are used interchangeably in electrophoresis. Molecular weight (M_r or relative molecular mass) is defined as the ratio of a molecule's mass to that of $\frac{1}{12}$ the mass of carbon 12 and is thus dimensionless. Molecular mass, not a ratio, is defined as the mass of one molecule and is generally expressed in Daltons (Da). One can say that myosin has a molecular mass of 205 000 Daltons (205 kDa) or a molecular weight of 205 000 (M_r 205 000). Note that molecular weight is a ratio without units and should not be expressed in daltons.

Ohm's law $V = IR$, where V = voltage (V), I = current (A), and R = resistance (Ohms, Ω). Various forms of the law are used in electrophoresis to determine the current, voltage, and power to use during a separation.

PAGE (polyacrylamide gel electrophoresis) The most widely used form of electrophoresis in the vertical format; uses polyacrylamide as the separation medium. Typically, it is used for smaller-molecular-weight DNA and proteins.

SDS (sodium dodecyl sulphate) An anionic detergent used in SDS gel electrophoresis. SDS binds to proteins at a fixed ratio of 1.4 g SDS per g of protein.

SDS-PAGE A variation of electrophoresis that uses the anionic detergent SDS to ensure that all proteins are denatured and carry a negative charge at a constant charge-to-mass ratio. With excess SDS conditions, protein mobility in an electrophoretic gel is related primarily to the size, not the intrinsic charge of the protein.

%T – The percentage of total monomer in a gel:

$$\%T = \frac{\text{g(acrylamide + bisacrylamide)}}{100 \text{ ml}} \times 100$$

TEMED The catalyst of acrylamide polymerization. Used with ammonium persulphate (initiator) to prepare polyacrylamide gels.

Triton X-100 (polyoxyethylene-p-isooctylphenol) A nonionic detergent commonly used in IEF. Sample concentrations up to 2% can be used.

urea A denaturant used for solubilizing proteins in denaturing IEF at concentrations of 8 M.

Western blotting (protein blotting) Electrophoretic transfer of electrophoretically separated proteins onto a nitrocellulose, PVDF, or nylon membrane. The membrane is a close replica of the original gel. The transferred proteins are readily accessible for probing with antibodies or other reagents.

Index

A

- Acrylamide
 - characteristics of as gel matrix, 6
 - chemical structure of, fig., 1
 - drying and storing gels, 61
 - recommendations for protein separations, 26
- Automated gel staining 58, 60
- Agarose
 - characteristics of as gel matrix, 6
 - chemical structure of, fig., 1
- Analysis of gels
 - documentation, 62
 - estimation of molecular weight, 62-65
 - gel drying and storage, 61
 - staining with Coomassie Blue, 55-58
 - silver staining, 58-60
 - troubleshooting, 39, 53, 66

B

- Bovine Erythrocyte Carbonic Anhydrase, IPG analysis of, 51
- Buffer systems
 - continuous, 15
 - discontinuous, 15
- Blotting, see Western transfer blotting

C

- Coomassie Brilliant Blue staining, 55-58

D

- Denaturing IEF, 48-50
- Densitometer, 62
- Detection of proteins in polyacrylamide gels, 8-11

E

- EEO, see Electroendosmosis
- Electroendosmosis (EEO) in gel running, 5
- Electrophoresis
 - apparatus set up for, 1, 2, 13-15
 - electrical parameters, 2-3
 - IEF, Chapter 3
 - preparing protein standards and samples for, 18, 21, 46, 49, 51
 - problems with
 - heat, 4-5, 39
 - polymerization, 8-10, 39
 - samples for, 40
 - SDS-PAGE, Chapter 2
 - theory of,
 - buffers and pH, 3-4
 - data analysis, 61-65
 - electrical parameters, 2-3
 - gel specifications, 1-2
 - matrix selection, 5-8
 - preparation of gels, 6-8
 - temperature regulation, 4-5
 - troubleshooting, 39, 53, 66
- Equipment choices, 13-14
- Estimation of protein molecular weight by SDS-PAGE, 62-65

F

Flatbed electrophoresis
SDS-PAGE, 36-38
IEF, Chapter 3
Frowning, in SDS-PAGE gels, 39

G

Gel documentation, 62
Glossary, 67-68
Gradient gels, see Linear gradient gels

H

Horizontal acrylamide gels, 1-2, 36-38, Chapter 3

I

IEF, see Isoelectric focusing
Immobilized pH gradient (IPG) gels, 43-44, 50-52
IPG gels, see Immobilized pH gradient gels
Isoelectric point
in isoelectric focusing, 10, 43-44
influence on buffer selection in electrophoresis, 4
Isoelectric focusing (IEF)
denaturing
solutions for, 48
materials and equipment for, 48
procedure for running gels, 48-50
immobilized pH gradients (IPG) in
procedure for running and gels, 50-52
reagents and equipment for, 50-51
native
solutions for, 45
materials and equipment for, 46
procedure for running gels, 46-47
theory, 4, 43-44
troubleshooting, 53

L

Laemmli SDS-PAGE system, 16
Linear gradient gels, preparing and running, 30-35

M

Matrix, selection of, 5-8
Minigels, in SDS-PAGE separations, 23-29
Molecular weight of proteins, calculating with SDS-PAGE, 62-65

N

Native gel electrophoresis, 36
Native IEF, 45-47

O

Ohm's Law, 2

P

- Precast acrylamide gels
 - for multiphor II system, 37, 45
- Photochemical polymerization, 7-8
- Polyacrylamide gels
 - drying and storing, 61
 - monomer preparation for, 6
 - polymerization of, 7-8
 - pore size determination in, 7
 - staining, 55-60
- Power equation, 2
- Protein
 - determining molecular weight of, 62-65
 - isoelectric focusing of, Chapter 3
 - separation of with SDS-PAGE gels, Chapter 2
 - staining in SDS-PAGE gels, 55-60
 - standards for gel separations, 18, 36

Q

- Quantitative analysis of data from electrophoresis, 9-10, 62-65

R

- Reagents and solutions, recipes
 - Acrylamide solution, 16
 - Ammonium persulfate (10%), 17
 - Anode Solution
 - for IEF gels, 45
 - Cathode Solution
 - for IEF gels, 45
 - Coomassie Blue Staining Solution, 56
 - Denaturing IEF rehydration solution, 48
 - Destaining
 - Solution I, 56
 - Solution II, 56
 - Developing Solution, 59
 - Fixing Solution
 - for Coomassie Blue staining
 - IEF gels, 56
 - Tris-tricine gels (small proteins), 56
 - for silver staining, 59
 - Glutaraldehyde fixing solution, 56
 - Gradient Gel Solution, 31-34 (Table)
 - IEF
 - anode solution, 45
 - cathode solution, 45
 - Preserving Solution, 59
 - Rehydration solution, 48
 - Resolving Gel
 - Buffer (4×), 16
 - Overlay, 17
 - Resolving Gel Solution for SDS
 - minigel, 25 (Table)
 - standard gel, 20 (Table)
 - SDS (10%), 17
 - Sensitizing Solution, 59
 - Silver Solution, 59
 - Silver staining fixing solution, 59
 - Stacking Gel Solution for SDS
 - minigel, 26 (Table)
 - standard gel, 20 (Table)
 - Stacking Gel Buffer (4×), 17
 - Staining solution, 56

Stop Solution, 59
Tank Buffer, 17
Treatment Buffer (2×), 17
Trichloro acetic acid fixing solution (for IEF gels), 56
Water-saturated n-butanol, 17

S

Scanners, 62

SDS-PAGE

buffer systems for, 15
calculating protein weights from, 62-65
drying and storing gels from, 61
equipment choices, 13-15
gel documentation, 62
preparing and running
 large gels, 19-23
 linear gels, 30-34
 minigels, 23-29
protein standards for, 18, 63
solutions, reagents, and equipment for, 16-18
staining gels from, 55-60
troubleshooting, 39-40
SDS-polyacrylamide gel electrophoresis; see SDS-PAGE
Silver staining
 method, 58-60
 reagents for, 59
Smiling, in SDS-PAGE gels, 39
Standards, 18, 63
Submarine gels, 2

T

Transfer, protein see Western transfer blotting

V

Vertical slab gels, casting, 2, Chapter 2

W

Western transfer blotting, 10-11



Notes:





Notes:





Notes:



Ampholine, CleanGel, Easy Breeze, ExcelGel, Gel Pool, Hoefer, ImageMaster, Immobiline, Mighty Small, Multiphor, MultiTemp, Pharmalyte, PhastSystem, Plus One, and Spacer-Mate are trademarks of AmershamBiosciences Limited or its subsidiaries.

Amersham and Amersham Biosciences is a trademark of Amersham plc.

Coomassie is a trademark of ICI Americas Inc.

Tris is a trademark of Union Carbide Chemicals and Plastics Co.

Hamilton is a trademark of Hamilton Company.

© 1999 Amersham Amersham Biosciences Inc.
All rights reserved.

All goods and services are sold subject to the terms and conditions of sale of the company within the Amersham Amersham Biosciences group that supplies them. A copy of these terms and conditions is available on request.

Printed in the USA.

Amersham Biosciences **UK Limited**
Amersham Place Little Chalfont
Buckinghamshire England HP7 9NA

Amersham Biosciences **AB**
SE-751 84 Uppsala Sweden

Amersham Biosciences **Inc.**
800 Centennial Avenue PO Box 1327
Piscataway NJ 08855 USA

Amersham Biosciences **Europe GmbH**
Munzinger Strasse 9 D-79111 Freiburg Germany

www.amershambiosciences.com

